

AddressLine

Address Line. Details
Address Line. Line. Text

UBL Name

AddressLine

Definition

Information about a line of address expressed as unstructured text.

Crd	Short name	Requirement/Definition	Mapping/Comment
1..1	Line	A line of address expressed as unstructured text.	08B CC: Address. Line One. Text UP TO AND INCLUDING Address. Line Six. Text 08B BIE: Trade_ Address. Line One. Text UP TO AND INCLUDING Trade_ Address. Line Six. Text

Address

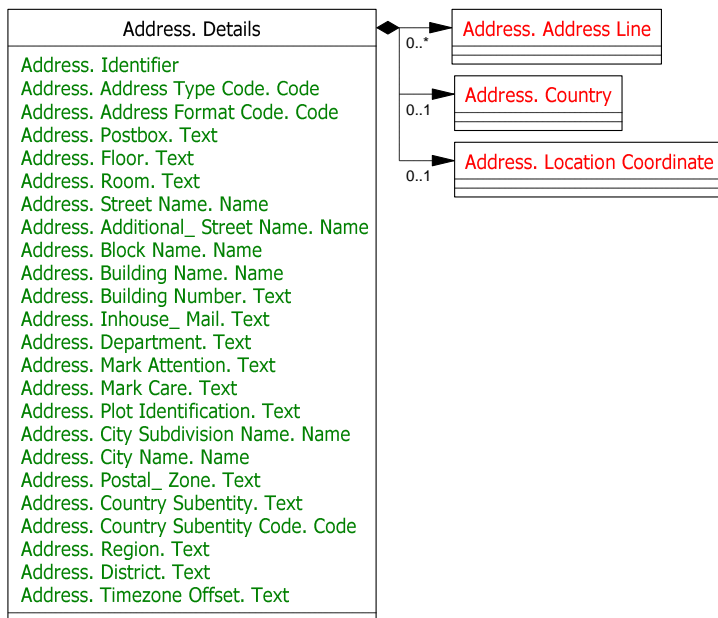

UBL Name

Address

Definition

Information about a structured address.

Crd	Short name	Requirement/Definition	Mapping/Comment
0..1	ID	An identifier for a specific address within a scheme of registered addresses. e.g., the GS1 (Formerly EAN) Global Location Number, GLN.	08B CC: Address. Identification. Identifier 08B BIE: Trade_ Address. Identification. Identifier
0..1	AddressTypeCode	A code specifying the type of this address, such as business address or home address.	08B CC: Address. Type. Code 08B BIE:
0..1	AddressFormatCode	A code specifying the format of this address.	08B CC: Address. Format. Code 08B BIE:
0..1	Postbox	A post office box number. See description	08B CC: Address. Post Office Box. Text 08B BIE: Trade_ Address. Post Office Box. Text
0..1	Floor	An addressable floor of a building.	08B CC: Address. Floor Identification. Text 08B BIE:
0..1	Room	A room, suite, or apartment of a building.	08B CC: Address. Room Identification. Text 08B BIE:
0..1	StreetName	The name of a street.	08B CC: Address. Street Name. Text 08B BIE: Trade_ Address. Street Name. Text
0..1	AdditionalStreetName	An additional name of a street used to further specify the street name.	08B CC: Address. Street Name. Text 08B BIE:
0..1	BlockName	The block name, expressed as text, for an area surrounded by streets and usually containing several buildings for this address.	08B CC: Address. Block Name. Text 08B BIE:

Crđ	Short name	Requirement/Definition	Mapping/Comment
0.. 1	BuildingName	The name of a building.	08B CC: Address. Building Name. Text 08B BIE: Trade_ Address. Building Name. Text
0.. 1	BuildingNumber	The number of a building.	08B CC: Address. Building Number. Text 08B BIE:
0.. 1	InhouseMail	A specific location within a building.	08B CC: Address. In-House Mail. Text 08B BIE:
0.. 1	Department	An addressable department of an organization.	08B CC: Address. Department Name. Text 08B BIE:
0.. 1	MarkAttention	The name, expressed as text, of a person or department in the organization to whom incoming mail is marked with words such as 'for the attention of' or 'FAO' or 'ATTN' for this address.	08B CC: Address. Attention Of. Text 08B BIE: Trade_ Address. Attention Of. Text
0.. 1	MarkCare	The name, expressed as text, of a person or organization at this address to whom incoming mail is marked with words such as 'care of' or 'C/O'.	08B CC: Address. Care Of. Text 08B BIE: Trade_ Address. Care Of. Text
0.. 1	PlotIdentification	The textual expression of the unique identifier for the piece of land on which this address is located such as a plot number.	08B CC: Address. Plot Identification. Text 08B BIE:
0.. 1	CitySubdivisionName	A name, expressed as text, of a subdivision of a city for this address, for example, a district or borough.	08B CC: Address. City Sub-Division Name. Text 08B BIE: Trade_ Address. City Sub-Division Name. Text
0.. 1	CityName	The name of a city, town, or village.	08B CC: Address. City Name. Text 08B BIE: Trade_ Address. City Name. Text
0.. 1	PostalZone	The identifier for an addressable group of properties according to the relevant national postal service, such as a ZIP code or Post Code.	08B CC: Address. Postcode. Code 08B BIE: Trade_ Address. Postcode. Code
0.. 1	CountrySubentity	A territorial division of a country, such as a county or state.	08B CC: Address. Country Sub-Division Name. Text OR Address. Country Identification. Country Sub-Division 08B BIE: Trade_ Address. Country Sub-Division Name. Text
0.. 1	CountrySubentityCode	A territorial division of a country, such as a county or state, expressed as a code.	08B CC: Address. Country Sub-Division. Identifier OR Address. Country Identification. Country Sub-Division 08B BIE: Trade_ Address. Country Sub-Division. Identifier
0.. 1	Region	An addressable region or group of countries.	08B CC: 08B BIE:
0.. 1	District	A geographical division of a country.	08B CC: Address. Township Name. Text 08B BIE:
0.. 1	TimezoneOffset	For the time zone in which the address is situated, the measure of time offset from Universal Coordinated Time (UTC).	08B CC: 08B BIE:
0.. unbound Association	AddressLine	An association to Address Line.	08B CC: Address. Line One. Text UP TO AND INCLUDING Address. Line Six. Text 08B BIE: Trade_ Address. Line One. Text UP TO AND INCLUDING Trade_ Address. Line Six. Text
0.. 1 Association	Country	An association to Country.	08B CC: Address. Country. Identifier OR Address. Country Identification. Country 08B BIE: Trade_ Address. Country Identification. Trade_ Country
0.. 1 Association	LocationCoordinate	An association to Location Coordinate.	08B CC: Address. Geo-Coordinate Identification. Geographical Coordinate 08B BIE: Trade_ Address. Geo-Coordinate Identification. Geographical Coordinate

AllowanceCharge

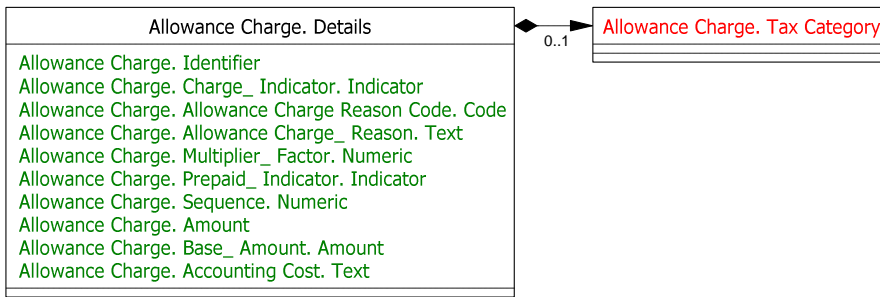

UBL Name **AllowanceCharge**
 Definition Information about a charge or discount price component.

Crd	Short name	Requirement/Definition	Mapping/Comment
0.. 1	ID	Identifies an Allowance Charge.	08B CC: Allowance Charge. Identification. Identifier 08B BIE: Trade_ Allowance Charge. Identification. Identifier
1.. 1	ChargeIndicator	Indicates whether the Allowance Charge is a charge (true) or a discount (false). Indicates whether the Allowance Charge is a Charge (True) and should be added or an Allowance (False) and should be subtracted.	08B CC: Allowance Charge. Charge. Indicator 08B BIE: Trade_ Allowance Charge. Charge. Indicator
0.. 1	AllowanceChargeReasonCode	The reason for the Allowance Charge, expressed as a code. Coded specification of the reason for the allowance	08B CC: Allowance Charge. Reason. Code 08B BIE: Trade_ Allowance Charge. Reason. Code
0.. 1	AllowanceChargeReason	The reason for the Allowance Charge, expressed as text. Use to explain reason for Allowance Charge even where Reason Code is present. Use in the absence of or in addition to a Reason Code.	08B CC: Allowance Charge. Reason. Text 08B BIE: Trade_ Allowance Charge. Reason. Text
0.. 1	MultiplierFactorNumeric	The factor applied to the Base Amount to calculate the Allowance Charge. Use only in conjunction with Base Amount. The factor by which the Base Amount is multiplied to calculate the Allowance Charge Amount. Use Factor to 3 decimal places.	08B CC: Allowance Charge. Calculation. Percent 08B BIE: Trade_ Allowance Charge. Calculation. Percent
0.. 1	PrepaidIndicator	Indicates whether the Allowance Charge is prepaid (true) or not (false).	08B CC: Allowance Charge. Prepaid. Indicator 08B BIE: Trade_ Allowance Charge. Prepaid. Indicator
0.. 1	SequenceNumeric	Identifies the numerical order sequence in which Allowance Charges are calculated when multiple Allowance Charges apply. If all Allowance Charges apply to the same Base Amount, SequenceNumeric will be '1' for all Allowance Charges.	08B CC: Allowance Charge. Sequence. Numeric 08B BIE: Trade_ Allowance Charge. Sequence. Numeric
1.. 1	Amount	The Allowance Charge amount.	08B CC: Allowance Charge. Actual. Amount 08B BIE: Trade_ Allowance Charge. Actual. Amount
0.. 1	BaseAmount	The amount to which the MultiplierFactorNumeric is applied to calculate the Allowance Charge. Use only in conjunction with Multiplier Factor. The Amount to which the Multiplier Factor is applied to calculate the Allowance Charge Amount.	08B CC: Allowance Charge. Basis. Amount 08B BIE: Trade_ Allowance Charge. Basis. Amount
0.. 1	AccountingCost	The buyer's accounting cost centre as applied to the Allowance Charge expressed as text. Use in the absence of a bilaterally agreed code.	08B CC: Allowance Charge. Specified. Accounting Account/Accounting Account. Cost Assignment Reference. Text 08B BIE: Trade_ Allowance Charge. Specified. Trade_ Accounting Account/Trade_ Accounting Account. Cost Assignment Reference. Text
0.. 1 Association	TaxCategory	An association to Tax Category.	08B CC: Allowance Charge. Category. Tax 08B BIE: Trade_ Allowance Charge. Category. Trade_ Tax

Attachment

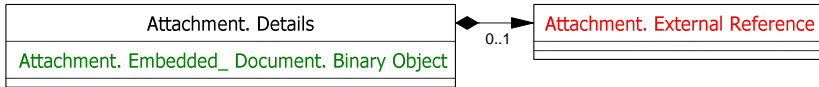

UBL Name

Attachment

Definition

Information about an attached document. An attachment can be referred to externally (with the URI element) or internally (with the MIME reference element) or contained within the document itself (with the EmbeddedDocument element).

Crd	Short name	Requirement/Definition	Mapping/Comment
0.. 1	EmbeddedDocumentBinary Object	Contains an embedded document as a BLOB (binary large object). Use in the absence of an External Reference.	08B CC: Document. Attachment. Binary Object 08B BIE: Referenced_ Document. Attachment. Binary Object
0.. 1 Association	ExternalReference	An attached document, externally referred to, referred to in the MIME location, or embedded. Use in the absence of an Embedded Document Binary Object.	08B CC: Document. Reference. Document 08B BIE: Referenced_ Document. Details

BillingReferenceLine

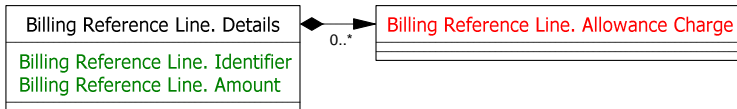

UBL Name

BillingReferenceLine

Definition

Information about the reference to a Billing line.

Crd	Short name	Requirement/Definition	Mapping/Comment
1.. 1	ID	An identifier for the Billing Line.	08B CC: Document. Line. Identifier 08B BIE: Referenced_ Document. Line. Identifier
0.. 1	Amount	The amount of the Billing Line, including Allowance Charges but net of taxes.	08B CC: Document. Line. Amount *Required to be added to CCL 08B BIE:
0.. unbound Association	AllowanceCharge	An association to Allowance Charge.	08B CC: Document. Line. Allowance Charge *Required to be added to CCL 08B BIE: Trade_ Allowance Charge. Details

BillingReference

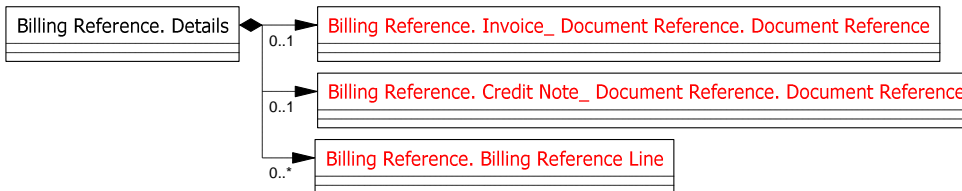

UBL Name

BillingReference

Definition

Information directly relating to a related document.

0.. 1 Association	InvoiceDocumentReference	An associative reference to Invoice.	08B CC: Trade Settlement. Referenced. Document 08B BIE: Supply Chain_ Trade Settlement. Invoice_ Referenced. Referenced_ Document
0.. 1 Association	CreditNoteDocumentReference	An associative reference to Credit Note.	08B CC: Trade Settlement. Referenced. Document 08B BIE: Supply Chain_ Trade Settlement. Invoice_ Referenced. Referenced_ Document
0.. unbound Association	BillingReferenceLine	An association to Billing Reference Line.	08B CC: Trade Settlement. Referenced. Document 08B BIE: Referenced_ Document. Line. X

Branch

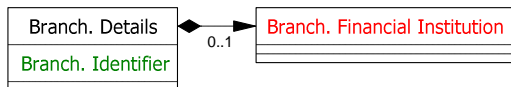

UBL Name

Branch

Definition

Information about a branch or division of an organization.

Crd	Short name	Requirement/Definition	Mapping/Comment
0..1	ID	An identifier for a branch or division of an organization.	08B CC: Financial Institution. Identification. Identifier 08B BIE: Branch_ Financial Institution. Identification. Identifier
0..1 Association	FinancialInstitution	An association to Financial Institution.	08B CC: Financial Institution. Sub-Division. Financial Institution 08B BIE: Creditor_ Financial Institution. Details

CardAccount

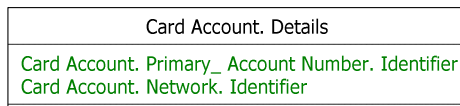

UBL Name

CardAccount

Definition

Information about a credit card, debit card, or charge card.

Crd	Short name	Requirement/Definition	Mapping/Comment
1..1	PrimaryAccountNumberID	The card number; the Primary Account Number (PAN). The card number. Bill strongly recommends putting only last digits of the card number, sufficient for the receiver to identify which of the cards he has on file is being reference. Generally last 4 or 6 digits.	08B CC: Financial Card. Identification. Identifier 08B BIE: Trade Settlement_ Financial Card. Identification. Identifier
1..1	NetworkID	The card network provider. Used to provid information about the issuer of the card i.e. Visa, Mastercard, Diners club, Amex etc.	08B CC: Financial Card. Network. Identifier *Required to be added to the CCL 08B BIE: Trade Settlement_ Financial Card. Network. Identifier * Required to be added to the CCL

CatalogueItemSpecificationUpdateLine

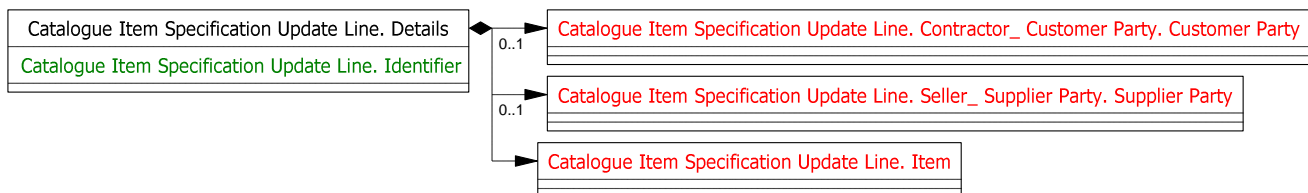

UBL Name

CatalogueItemSpecificationUpdateLine

Definition

Details of Catalogue Line Item Specification.

Crd	Short name	Requirement/Definition	Mapping/Comment
1..1	ID	A unique instance identifier for the line in this Catalogue document.	08B CC: Catalogue Item Specification Update Line. Identification. Identifier *Required to be added to CCL 08B BIE:

0.. 1 Association	ContractorCustomerParty	The Customer Party responsible for the contract to which the Catalogue relates.	08B CC: Catalogue Item Specification Update Line. Contractor . Party *Required to be added to CCL 08B BIE: Trade_Party_Details
0.. 1	SellerSupplierParty	An association to the Seller of the item.	08B CC: Catalogue Item Specification Update

Association			Line. Seller. Party *Required to be added to CCL 08B BIE: Trade_Party. Details
1..1 Association	Item	An association to Item itself.	08B CC: Catalogue Item Specification Update Line. Updated. Product *Required to be added to CCL 08B BIE: Trade_Product. Details

CatalogueLine

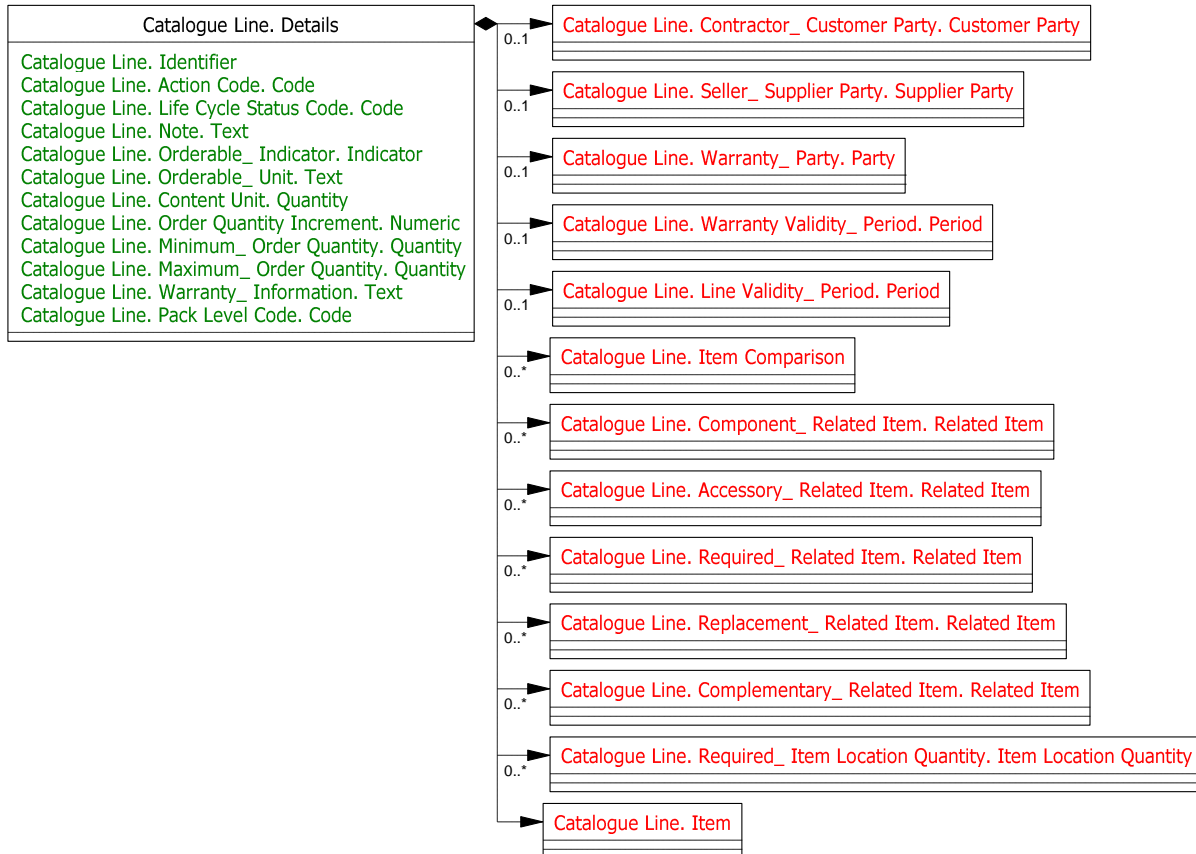

UBL Name

CatalogueLine

Definition

The basic element of Catalogue; something that can be bought.

Crđ	Short name	Requirement/Definition	Mapping/Comment
1..1	ID	A unique instance identifier for the line in this Catalogue document. Used as reference to the catalogue line when revising the catalogue.	08B CC: Catalogue Line. Identification. Identifier *Required to be added to CCL 08B BIE:
1..1	ActionCode	Code indicating the action required for this item to synchronize with external repositories. Used to indicate the action that should be taken on the identified line when revising a catalogue. See rule on catalogue version ID. When using Update or Delete codes, the entire Catalogue Line is updated or deleted.	08B CC: Catalogue Line. Action. Code *Required to be added to CCL 08B BIE:
0..1	LifeCycleStatusCode	Code indicating availability of this line. Used to specify where in the product life cycle the catalogue line item is.	08B CC: Catalogue Line. Life Cycle Status. Code *Required to be added to CCL 08B BIE:
0.. unbound ed	Note	Free-text note used for non-structured information about the line in the specific Catalogue document (intended to be human readable). Used to describe any additional information on the line that can not be expressed in specific fields.	08B CC: Catalogue Line. Note. Text *Required to be added to CCL 08B BIE:

1.. 1	OrderableIndicator	Indicates whether the line is orderable (that is, not just for information only). Default value is True i.e. Item on the Catalogue Line can be ordered. Can be used to indicate if an Item is temporarily out of stock (via a Catalogue Update).	08B CC: Catalogue Line. Orderable. Indicator *Required to be added to CCL 08B BIE:
0.. 1	OrderableUnit	The unit that can be ordered. The unit in which the item can be ordered.	08B CC: Catalogue Line. Orderable Unit. Text *Required to be added to CCL 08B BIE:

Crđ	Short name	Requirement/Definition	Mapping/Comment
1.. 1	ContentUnitQuantity	The quantity of the order unit of measure of the line. Specifies the number of items that are in each order able unit.	08B CC: Catalogue Line. Content Unit. Quantity *Required to be added to CCL 08B BIE:
0.. 1	OrderQuantityIncrementNumeric	The number of items that can set the order quantity increments. The increment of Orderable units that can be ordered. If Orderable Unit is case (CS) and Order Quantity Increment is 6, then only 6, 12, 18, 24 ... cases can be ordered.	08B CC: Catalogue Line. Order Quantity Increment. Numeric *Required to be added to CCL 08B BIE:
0.. 1	MinimumOrderQuantity	The minimum amount of items that can be ordered. The minimum number of orderable units that can be ordered.	08B CC: Catalogue Line. Order. Quantity *Required to be added to CCL 08B BIE:
0.. 1	MaximumOrderQuantity	The maximum amount of items that can be ordered. The maximum number of orderable units that can be ordered.	08B CC: Catalogue Line. Order. Quantity *Required to be added to CCL 08B BIE:
0.. unbound	WarrantyInformation	Information regarding the warranty for the good or service. Warranty may be provided by any Party (can be described in the association to Warranty Party).	08B CC: Catalogue Line. Warranty Information. Text *Required to be added to CCL 08B BIE:
0.. 1	PackLevelCode	The level of packaging involved. Used for logistical definition of packaging.	08B CC: Catalogue Line. Pack Level. Code *Required to be added to CCL 08B BIE:
0.. 1 Association	ContractorCustomerParty	The Customer Party responsible for the contract to which the Catalogue relates. Specifies what party is allowed to order this particular catalogue line. Used in a multi party catalogue.	08B CC: Catalogue Line. Contractor. Party *Required to be added to CCL 08B BIE: Trade_ Party. Details
0.. 1 Association	SellerSupplierParty	An association to Seller of the item. Specifies what party supplies this particular catalogue line. Used in a multi party catalogue.	08B CC: Catalogue Line. Seller. Party *Required to be added to CCL 08B BIE: Trade_ Party. Details
0.. 1 Association	WarrantyParty	The party responsible for the Warranty. The party who is responsible for the warranty for the product or services in the line.	08B CC: Catalogue Line. Warranty. Party *Required to be added to CCL 08B BIE: Trade_ Party. Details
0.. 1 Association	WarrantyValidityPeriod	The period for which the Warranty is valid. The period that the warranty is valid.	08B CC: Catalogue Line. Warranty Validity. Period *Required to be added to CCL 08B BIE: Specified_ Period. Details
0.. 1 Association	LineValidityPeriod	The period for which the Catalogue Line is valid. The period during which the information in the catalogue line is valid. An orderable catalogue item is no longer orderable after the validity period expires. Used for example for promotional item or prices.	08B CC: Catalogue Line. Line Validity. Period *Required to be added to CCL 08B BIE: Specified_ Period. Details
0.. unbound Association	ItemComparison	An association to comparative details for this Item. Used to provide price information based on a standard quantity unit to enable price comparison.	08B CC: Catalogue Line. Item Comparison *Required to be added to CCL 08B BIE:
0.. unbound Association	ComponentRelatedItem	An association that describes any catalogue items that may be components of this Item. See description.	08B CC: Catalogue Line. Component. Related Item *Required to be added to CCL 08B BIE:
0.. unbound Association	AccessoryRelatedItem	An association that describes any catalogue items that may be optional accessories to this Item. As described.	08B CC: Catalogue Line. Accessory. Related Item *Required to be added to CCL 08B BIE:
0.. unbound Association	RequiredRelatedItem	An association that describes any catalogue items that may be required for this Item. As described.	08B CC: Catalogue Line. Required. Related Item *Required to be added to CCL 08B BIE:
0.. unbound Association	ReplacementRelatedItem	An association that describes any catalogue items that may be replacements for this Item. As described.	08B CC: Catalogue Line. Replacement_ Related Item. Related Item *Required to be added to CCL 08B BIE:
0.. unbound Association	ComplementaryRelatedItem	An association that describes any catalogue items that may complement this Item. As described.	08B CC: Catalogue Line. Complementary. Related Item *Required to be added to CCL 08B BIE:
0.. unbound	RequiredItemLocationQuant	An association to the description of properties	08B CC: Catalogue Line. Required. Item Location

ed Association	ity	related to locations and quantities of the Item. Used to specify the price of the item. Can also be used to specify prices that may be dependent on quantities and/or locations.	Quantity *Required to be added to CCL 08B BIE:
1..1 Association	Item	An association to the Item itself. Used to specify the details of the item in the catalogue.	08B CC: Catalogue Line. Specified. Product *Required to be added to CCL 08B BIE: Trade_ Product. Details

CataloguePricingUpdateLine



UBL Name **CataloguePricingUpdateLine**
 Definition Details of Catalogue Line Pricing.

Crđ	Short name	Requirement/Definition	Mapping/Comment
1..1	ID	A unique instance identifier for the line in this Catalogue document.	08B CC: Catalogue Pricing Update Line. Identification. Identifier *Required to be added to CCL 08B BIE:
0..1 Association	ContractorCustomerParty	The Customer Party responsible for the contract to which the Catalogue relates.	08B CC: Catalogue Pricing Update Line. Contractor. Party *Required to be added to CCL 08B BIE: Trade_ Party. Details
0.. unbound Association	RequiredItemLocationQuantity	An association to the description of properties related to locations and quantities of the item.	08B CC: Catalogue Pricing Update Line. Required. Item Location Quantity *Required to be added to CCL 08B BIE:

CatalogueReference

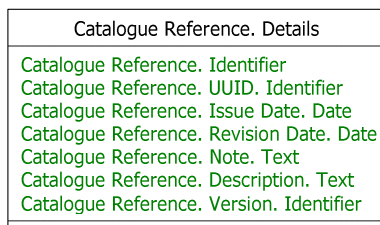

UBL Name **CatalogueReference**
 Definition A reference to a Catalogue.

Crđ	Short name	Requirement/Definition	Mapping/Comment
1..1	ID	Identifies a reference to a Catalogue document.	08B CC: Catalogue Reference. Identification. Identifier *Required to be added to CCL 08B BIE:
0..1	UUID	A universally unique identifier for an instance of this ABIE.	08B CC: Catalogue Reference. UUID. Identifier *Required to be added to CCL 08B BIE:
0..1	IssueDate	The date when the Catalogue was issued.	08B CC: Catalogue Reference. Issue. Date *Required to be added to CCL 08B BIE:
0..1	RevisionDate	The date on which the information in the Catalogue was revised.	08B CC: Catalogue Reference. Revision. Date *Required to be added to CCL 08B BIE:
0.. unbound	Note	A free-text note about the Catalogue. This is used for information which is only human readable.	08B CC: Catalogue Reference. Note. Text *Required to be added to CCL 08B BIE:
0.. unbound	Description	A description of the Catalogue.	08B CC: Catalogue Reference. Description. Text *Required to be added to CCL 08B BIE:
1..1	VersionID	Indicates the current version of the Catalogue.	08B CC: Catalogue Reference. Version. Identifier

Crd	Short name	Requirement/Definition	Mapping/Comment
			*Required to be added to CCL 08B BIE:

CatalogueRequestLine

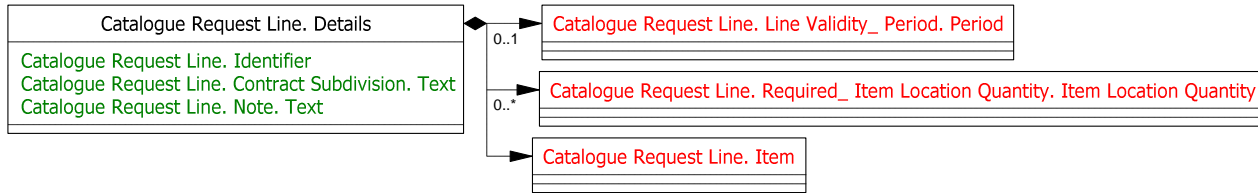

UBL Name **CatalogueRequestLine**
 Definition The basic element of Catalogue; something that can be bought.

Crd	Short name	Requirement/Definition	Mapping/Comment
1..1	ID	A unique instance identifier for the line in this Catalogue document.	08B CC: Catalogue Request Line. Identification. Identifier *Required to be added to CCL 08B BIE:
0..1	ContractSubdivision	Identifies a subdivision of a contract or tender.	08B CC: Catalogue Request Line. Contract Subdivision. Text *Required to be added to CCL 08B BIE:
0.. unbound ed	Note	Free-text note used for non-structured information about the line in the specific Catalogue document (intended to be human readable).	08B CC: Catalogue Request Line. Note. Text *Required to be added to CCL 08B BIE:
0..1 Association	LineValidityPeriod	The period for which the Catalogue Line is valid.	08B CC: Catalogue Request Line. Line Validity. Period *Required to be added to CCL 08B BIE: Specified_ Period. Details
0.. unbound ed Association	RequiredItemLocationQuantity	An association to the description of properties related to locations and quantities of the item.	08B CC: Catalogue Request Line. Required. Item Location Quantity *Required to be added to CCL 08B BIE:
1..1 Association	Item	An association to the Item itself.	08B CC: Catalogue Request Line. Requested. Product *Required to be added to CCL 08B BIE: Trade_ Product. Details

ClassificationCategory

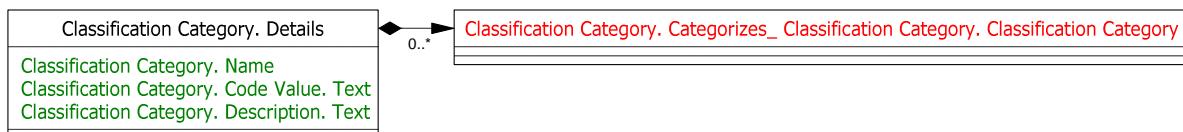

UBL Name **ClassificationCategory**
 Definition Information about a Classification Category; a subdivision of a Classification Scheme.

Crd	Short name	Requirement/Definition	Mapping/Comment
0..1	Name	The name of the Classification Category.	08B CC: Classification. Class Name. Text 08B BIE: Product_ Classification. System Name. Text
0..1	CodeValue	The Classification Category value.	08B CC: Classification. Class. Code 08B BIE: Product_ Classification. Class. Code
0.. unbound ed	Description	The description of the Classification Category.	08B CC: Classification. Class Name. Text 08B BIE:
0.. unbound ed Association	CategorizesClassificationCategory	An association to subcategories within the Category.	08B CC: Classification. Categorized. Classification *Required to be added to CCL 08B BIE: Product_ Classification. Details

ClassificationScheme

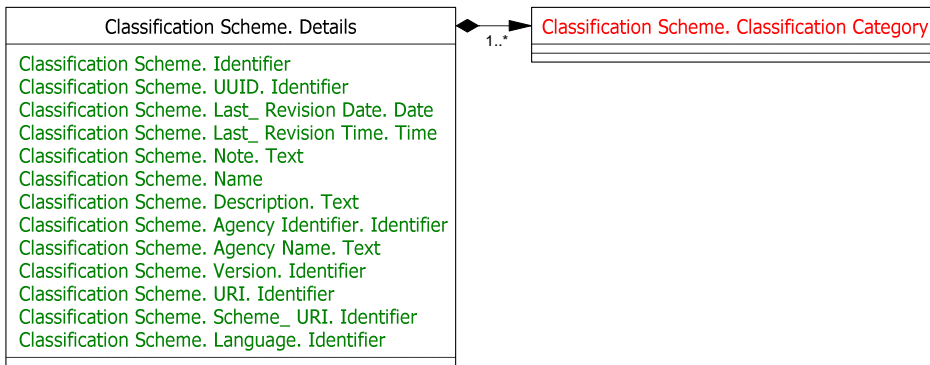

UBL Name

ClassificationScheme

Definition

Information about Classification Scheme; a scheme that defines a taxonomy for classifying goods or services.

Crđ	Short name	Requirement/Definition	Mapping/Comment
1.. 1	ID	An identifier for the classification scheme.	08B CC: Classification. System. Identifier 08B BIE:
0.. 1	UUID	A universally unique identifier for an instance of this ABIE.	08B CC: Classification. UUID. Identifier *Required to be added to CCL 08B BIE:
0.. 1	LastRevisionDate	The date at which the classification scheme was last revised.	08B CC: Classification. Revision. Event *Required to be added to CCL 08B BIE:
0.. 1	LastRevisionTime	The time at which the classification scheme was last revised.	08B CC: Classification. Revision. Event *Required to be added to CCL 08B BIE:
0.. 1	Note	Free-form text applying to the Classification Scheme. This element may contain notes or any other similar information that is not contained explicitly in another structure.	08B CC: Classification. Note. Text *Required to be added to CCL 08B BIE:
0.. 1	Name	The name of the Classification Scheme.	08B CC: Classification. System Name. Text 08B BIE:
0.. unbound ed	Description	A description of the Classification Scheme.	08B CC: Classification. Description. Text *Required to be added to CCL 08B BIE:
0.. 1	AgencyID	Identifies the agency that maintains the Classification Scheme.	08B CC: Classification. Agency. Identifier *Required to be added to CCL 08B BIE:
0.. 1	AgencyName	The name of the agency that maintains the Classification Scheme.	08B CC: Classification. Agency Name. Text *Required to be added to CCL 08B BIE:
0.. 1	VersionID	Identifies the version of the Classification Scheme.	08B CC: Classification. Version. Identifier *Required to be added to CCL 08B BIE:
0.. 1	URI	The Uniform Resource Identifier (URI) that identifies where the Classification is located.	08B CC: Classification. URI. Identifier *Required to be added to CCL 08B BIE:
0.. 1	SchemeURI	The Uniform Resource Identifier (URI) that identifies where the Classification Scheme is located.	08B CC: Classification. Scheme URI. Identifier *Required to be added to CCL 08B BIE:
0.. 1	LanguageID	Identifies the language of the Classification Scheme.	08B CC: Classification. Language. Identifier *Required to be added to CCL 08B BIE:
1.. unbound ed Association	ClassificationCategory	An association to Classification Category.	08B CC: Classification. Details 08B BIE: Product_ Classification. Details

CommodityClassification

Commodity Classification. Details
Commodity Classification. Commodity Code. Code Commodity Classification. Item Classification Code. Code

UBL Name **CommodityClassification**
 Definition Information about Commodity Classification.

Crd	Short name	Requirement/Definition	Mapping/Comment
0.. 1	CommodityCode	The harmonized international commodity code for regulatory (customs and trade statistics) purposes. A regulatory commodity classification code other than UN/SPSC.	08B CC: Classification. Class. Code 08B BIE:
0.. 1	ItemClassificationCode	The trade commodity classification, expressed as a code. A classification code used to classify the type or nature of the Item. More than one classifications can be used . In EU tendering the CPV code must also be provided.	08B CC: Classification. Class. Code 08B BIE:

Communication

Communication. Details
Communication. Channel Code. Code Communication. Channel. Text Communication. Value. Text

UBL Name **Communication**
 Definition Information about a means of communication.

Crd	Short name	Requirement/Definition	Mapping/Comment
0.. 1	ChannelCode	The method of communication, expressed as a code.	08B CC: Communication. Channel. Code 08B BIE: Universal_ Communication. Channel. Code
0.. 1	Channel	The method of communication, expressed as text.	08B CC: 08B BIE:
1.. 1	Value	The communication value, such as phone number or email address.	08B CC: Communication. URI. Identifier OR Communication. Complete Number. Text 08B BIE: Universal_ Communication. URI. Identifier OR Universal_ Communication. Complete Number. Text

Contact

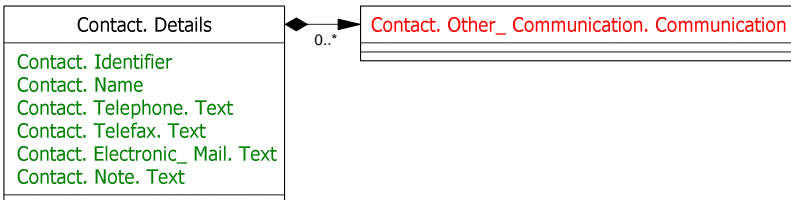

UBL Name **Contact**
 Definition Information about a contactable person or organization department.

Crd	Short name	Requirement/Definition	Mapping/Comment
0.. 1	ID	An identifier for the Contact.	08B CC: Contact. Identification. Identifier 08B BIE: Trade_Contact. Identification. Identifier
0.. 1	Name	The name of the Contact.	08B CC: Contact. Job Title. Text OR Contact. Person Name. Text 08B BIE: Trade_Contact. Person Name. Text
0.. 1	Telephone	The telephone number of the Contact.	08B CC: Contact. Telephone. Communication

Crđ	Short name	Requirement/Definition	Mapping/Comment
			08B BIE: Trade_Contact. Telephone. Universal_Communication
0.. 1	Telefax	The fax number of the Contact.	08B CC: Contact. Fax. Communication 08B BIE: Trade_Contact. Fax. Universal_Communication
0.. 1	ElectronicMail	The email address of the Contact.	08B CC: Contact. URI. Communication 08B BIE: Trade_Contact. URI. Universal_Communication
0.. 1	Note	A note such as 'Emergency' or 'After Hours' describing the circumstances in which the Contact can be used.	08B CC: Contact. Specified. Note 08B BIE: Trade_Contact. Specified. Note
0.. unbound Association	OtherCommunication	An association to Other Communication.	08B CC: Contact. VOIP. Communication OR Contact. Instant Messaging. Communication 08B BIE: Trade_Contact. VOIP. Universal_Communication OR Trade_Contact. Instant Messaging. Universal_Communication

Contract



UBL Name

Contract

Definition

Information about a Contract.

Crđ	Short name	Requirement/Definition	Mapping/Comment
1.. 1	ID	Identifies the Contract. A mutually understood Identifier for the Contract.	08B CC: Contract. Identification. Identifier 08B BIE: Trade_Contract. Identification. Identifier
0.. 1	IssueDate	The date on which the Contract was issued.	08B CC: Contract. Issue. Date Time 08B BIE: Trade_Contract. Issue. Date Time
0.. 1	ContractType	The type of Contract, expressed as text. Use in the absence of a Contract Type Code.	08B CC: Contract. Name. Text 08B BIE:
0.. 1 Association	ContractDocumentReference	An associative reference to Contract Document.	08B CC: Contract. Reference. Document 08B BIE: Referenced_Document. Details

CorporateRegistrationScheme

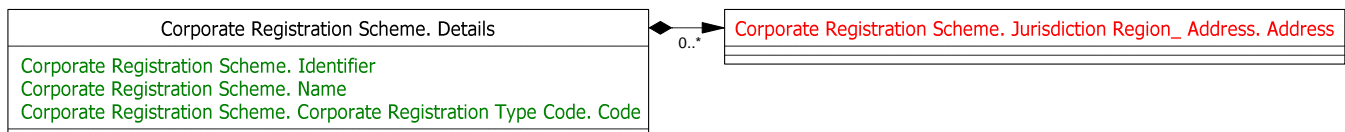

UBL Name

CorporateRegistrationScheme

Definition

Information directly relating a scheme for corporate registration of businesses.

Crđ	Short name	Requirement/Definition	Mapping/Comment
0.. 1	ID	Identifies the scheme.	08B CC: Registration. Identification. Identifier 08B BIE: Legal_Registration. Identification. Identifier
0.. 1	Name	Identifies the scheme by name.	08B CC: Registration. Name. Text *Required to be added to CCL 08B BIE:
0.. 1	CorporateRegistrationTypeCode	Identifies the type of scheme.	08B CC: Registration. Type. Code 08B BIE: Legal_Registration. Type. Code
0.. unbound Association	JurisdictionRegionAddress	Associates the registration scheme with particulars that identify and locate the geographic area to which the scheme applies.	08B CC: Registration. Country Sub-division. Identifier 08B BIE: Legal_Registration. Country Sub-Division. Identifier

Country

Country. Details
Country. Identification Code. Code Country. Name

UBL Name **Country**
 Definition Information about a geopolitical country.

Crd	Short name	Requirement/Definition	Mapping/Comment
1..1	IdentificationCode	An identifier for the Country.	08B CC: Country. Identification. Identifier 08B BIE: Trade_Country. Identification. Identifier
0..1	Name	The name of the Country.	08B CC: Country. Name. Text 08B BIE: Trade_Country. Name. Text

CreditAccount

Credit Account. Details
Credit Account. Account Identifier. Identifier

UBL Name **CreditAccount**
 Definition Information about a Credit Account (for sales on account).

Crd	Short name	Requirement/Definition	Mapping/Comment
1..1	AccountID	Identifies the Credit Account.	08B CC: Financial Account. Identification. Identifier 08B BIE: Creditor_Financial Account. IBAN_ Identification. Identifier Creditor_Financial Account. BBAN_ Identification. Identifier Creditor_Financial Account. UPIC_ Identification. Identifier Creditor_Financial Account. Proprietary_ Identification. Identifier

CreditNoteLine

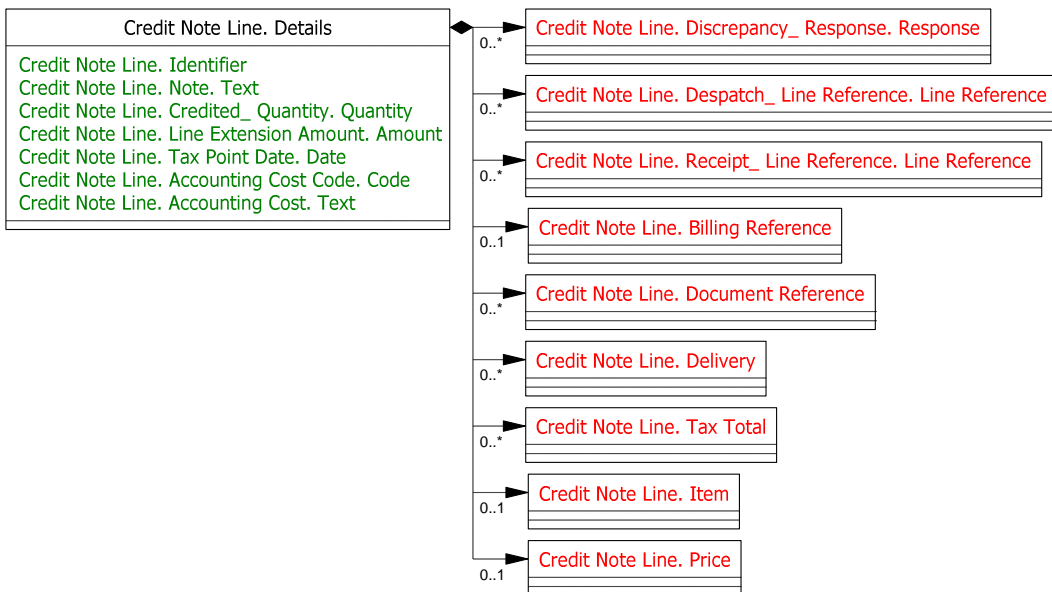

UBL Name **CreditNoteLine**
 Definition Information about a Credit Note Line.

Crd	Short name	Requirement/Definition	Mapping/Comment
1..1	ID	Identifies the Credit Note Line.	08B CC: Trade Line Item. Associated. Document/Document. Line. Identifier

Crd	Short name	Requirement/Definition	Mapping/Comment
			08B BIE: Supply Chain_ Trade Line Item. Associated. Document Line_ Document/Document Line_ Document. Line. Identifier
0.. 1	Note	Free-form text applying to the Credit Note Line. This element may contain notes or any other similar information that is not contained explicitly in another structure.	08B CC: Trade Line Item. Associated. Document/Document. Included. Note 08B BIE: Supply Chain_ Trade Line Item. Associated. Document Line_ Document/Document Line_ Document. Included. Note
0.. 1	CreditedQuantity	The quantity of Items credited.	08B CC: Trade Line Item. Chargeable Unit. Quantity 08B BIE:
1.. 1	LineExtensionAmount	The total amount for the Credit Note Line, including Allowance Charges but net of taxes.	08B CC: Trade Line Item. Specified. Trade Settlement/Trade Settlement. Specified. Monetary Summation/Monetary Summation. Line Total. Amount 08B BIE: Supply Chain_ Trade Line Item. Specified. Supply Chain_ Trade Settlement/Supply Chain_ Trade Settlement. Specified. Trade Settlement_ Monetary Summation/Trade Settlement_ Monetary Summation. Line Total. Amount
0.. 1	TaxPointDate	The date of the Credit Note Line, used to indicate the point at which tax becomes applicable.	08B CC: Trade Line Item. Specified. Trade Settlement/Trade Settlement. Applicable. Tax/Tax. Tax Point. Date 08B BIE: Supply Chain_ Trade Line Item. Specified. Supply Chain_ Trade Settlement/Supply Chain_ Trade Settlement. Applicable. Trade_ Tax/ Trade_ Tax. Tax Point. Date
0.. 1	AccountingCostCode	The buyer's accounting code applied to the Credit Note Line.	08B CC: Trade Line Item. Specified. Trade Settlement/Trade Settlement. Specified. Accounting Account/Accounting Account. Identification. Identifier 08B BIE: Supply Chain_ Trade Line Item. Specified. Supply Chain_ Trade Settlement/Supply Chain_ Trade Settlement. Specified. Trade_ Accounting Account/Trade_ Accounting Account. Identification. Identifier
0.. 1	AccountingCost	The buyer's accounting cost centre applied to the Credit Note Line, expressed as text.	08B CC: Trade Line Item. Specified. Trade Settlement/Trade Settlement. Specified. Accounting Account/Accounting Account. Cost Assignment Reference. Text 08B BIE: Supply Chain_ Trade Line Item. Specified. Supply Chain_ Trade Settlement/Supply Chain_ Trade Settlement. Specified. Trade_ Accounting Account/Trade_ Accounting Account. Cost Assignment Reference. Text
0.. unbound Association	DiscrepancyResponse	An association to Discrepancy Response; the reason for the Credit.	08B CC: Trade Line Item. Specified. Trade Settlement/Trade Settlement. Specified. Adjustment 08B BIE: Supply Chain_ Trade Line Item. Specified. Supply Chain_ Trade Settlement/Supply Chain_ Trade Settlement. Specified. Financial_ Adjustment
0.. unbound Association	DespatchLineReference	An associative reference to Despatch Line.	08B CC: Trade Line Item. Specified. Trade Delivery/ Trade Delivery. Referenced. Document 08B BIE: Supply Chain_ Trade Line Item. Specified. Supply Chain_ Trade Delivery/Supply Chain_ Trade Delivery. Despatch Advice_ Referenced.

			Referenced_Document
0.. unbound Association	ReceiptLineReference	An associative reference to Receipt Line.	08B CC: Trade Line Item. Specified. Trade Delivery/Trade Delivery. Referenced. Document 08B BIE: Supply Chain_ Trade Line Item. Specified. Supply Chain_ Trade Delivery/Supply Chain_ Trade Delivery. Receiving Advice_ Referenced. Referenced_Document
0.. 1 Association	BillingReference	An association to Billing Reference.	08B CC: Trade Line Item. Specified. Trade Settlement/Trade Settlement. Referenced. Document 08B BIE: Supply Chain_ Trade Line Item. Specified. Supply Chain_ Trade Settlement/Supply Chain_ Trade Settlement. Invoice_ Referenced. Referenced_Document
0.. unbound Association	DocumentReference	An association to Document Reference.	08B CC: Trade Line Item. Specified. Trade Settlement/Trade Settlement. Referenced. Document 08B BIE: Supply Chain_ Trade Line Item. Specified. Supply Chain_ Trade Settlement/Supply Chain_ Trade Settlement. Additional_ Referenced. Referenced_Document
0.. unbound Association	Delivery	An association to Delivery.	08B CC: Trade Line Item. Specified. Trade Delivery 08B BIE: Supply Chain_ Trade Line Item. Specified. Supply Chain_ Trade Delivery
0.. unbound Association	TaxTotal	An association to Tax Total.	08B CC: Trade Line Item. Specified. Trade Settlement/Trade Settlement. Applicable. Tax 08B BIE: /Supply Chain_ Trade Line Item. Specified. Supply Chain_ Trade Settlement/Supply Chain_ Trade Settlement. Applicable. Trade_ Tax
0.. 1 Association	Item	An association to Item	08B CC: Trade Line Item. Specified. Product 08B BIE: Supply Chain_ Trade Line Item. Specified. Trade_ Product
0.. 1 Association	Price	An association to Price.	08B CC: Trade Agreement. Product. Price 08B BIE: Supply Chain_ Trade Agreement. Agreed Price_ Product. Trade_ Price

CustomerParty

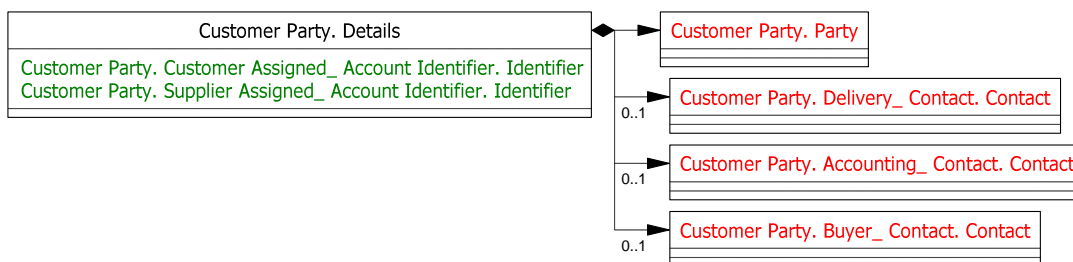

UBL Name

CustomerParty

Definition

Information about the Customer Party.

Crđ	Short name	Requirement/Definition	Mapping/Comment
0.. 1	CustomerAssignedAccountID	An identifier for the Customer's account, assigned by the Customer itself.	08B CC: Party. Identification. Identifier 08B BIE:
0.. 1	SupplierAssignedAccountID	An identifier for the Customer's account, assigned by the Supplier.	08B CC: Party. Identification. Identifier 08B BIE:
1.. 1 Association	Party	An association to Party.	08B CC: Party. Details 08B BIE: Trade_ Party. Details
0.. 1 Association	DeliveryContact	An association to Delivery Contact.	08B CC: Party. Defined. Contact 08B BIE: Trade_ Party. Defined. Trade_ Contact
0.. 1 Association	AccountingContact	An association to Accounting Contact (Customer).	08B CC: Party. Defined. Contact 08B BIE: Trade_ Party. Defined. Trade_ Contact

0.. 1 Association	BuyerContact	An association to Buyer Contact.	08B CC: Party. Defined. Contact 08B BIE: Trade_Party. Defined. Trade_Contact
----------------------	--------------	----------------------------------	---

DeliveryTerms

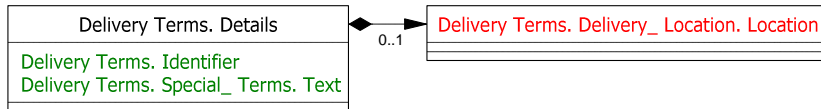

UBL Name **DeliveryTerms**
 Definition Information about Delivery Terms.

Crd	Short name	Requirement/Definition	Mapping/Comment
0.. 1	ID	Identifies the Delivery Terms.	08B CC: Delivery Terms. Delivery Type. Code 08B BIE: Trade_Delivery Terms. Delivery Type. Code
0.. 1	SpecialTerms	A description of special conditions relating to the Delivery Terms.	08B CC: Delivery Terms. Description. Text 08B BIE: Trade_Delivery Terms. Description. Text
0.. 1 Association	DeliveryLocation	An association to Location, e.g., a port.	08B CC: Delivery Terms. Relevant. Location 08B BIE: Trade_Delivery Terms. Relevant. Trade_Location

DeliveryUnit

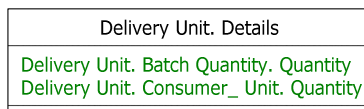

UBL Name **DeliveryUnit**
 Definition Information about a Delivery Unit.

Crd	Short name	Requirement/Definition	Mapping/Comment
1.. 1	BatchQuantity	The quantity of ordered Items that constitutes a batch for delivery purposes.	08B CC: Delivery. Unit. Quantity 08B BIE:
0.. 1	ConsumerUnitQuantity	The quantity of consumer units in the Delivery Unit.	08B CC: Delivery. Unit. Quantity 08B BIE:

Delivery

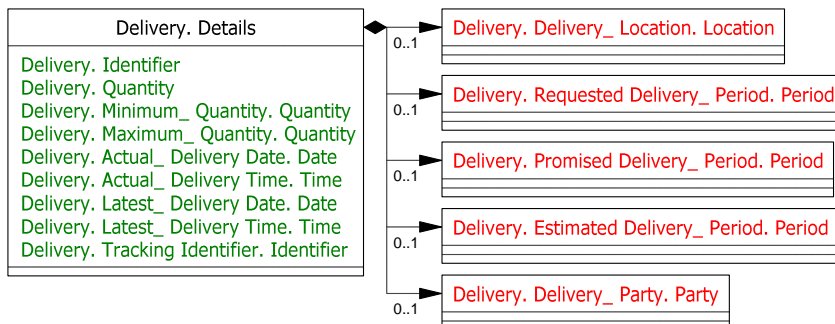

UBL Name **Delivery**
 Definition Information about Delivery.

Crd	Short name	Requirement/Definition	Mapping/Comment
0.. 1	ID	Identifies the Delivery.	08B CC: Trade Delivery. Identification. Identifier *Required to be added to CCL 08B BIE:
0.. 1	Quantity	The quantity in a Delivery.	08B CC: Trade Delivery. Unit. Quantity 08B BIE: Supply Chain_Trade Delivery.

Crd	Short name	Requirement/Definition	Mapping/Comment
			Despatched. Quantity
0..1	MinimumQuantity	The minimum quantity in a Delivery.	08B CC: Trade Delivery. Unit. Quantity 08B BIE:
0..1	MaximumQuantity	The maximum quantity in a Delivery.	08B CC: Trade Delivery. Unit. Quantity 08B BIE:
0..1	ActualDeliveryDate	The actual Delivery date.	08B CC: Trade Delivery. Delivery. Event/Event. Occurrence. Date Time 08B BIE: Supply Chain_ Trade Delivery. Actual_Delivery. Supply Chain_ Event/Supply Chain_ Event. Occurrence. Date Time
0..1	ActualDeliveryTime	The actual Delivery time.	08B CC: Trade Delivery. Delivery. Event/Event. Occurrence. Date Time 08B BIE: Supply Chain_ Trade Delivery. Actual_Delivery. Supply Chain_ Event
0..1	LatestDeliveryDate	The latest delivery date allowed by the buyer.	08B CC: Trade Delivery. Delivery. Event/Event. Occurrence. Date Time 08B BIE:
0..1	LatestDeliveryTime	The latest delivery time allowed by the buyer.	08B CC: Trade Delivery. Delivery. Event/Event. Occurrence. Date Time 08B BIE:
0..1	TrackingID	The delivery Tracking ID (for transport tracking). Used to provide a tracking id for delivery e.g. UPS or postal.	08B CC: Trade Delivery. Tracking. Identifier *Required to be added to CCL 08B BIE:
0..1 Association	DeliveryLocation	An association to Location.	08B CC: Trade Delivery. Delivery. Location *Required to be added to CCL 08B BIE: Supply Chain_ Trade Delivery. Actual_Delivery. Supply Chain_ Event/Supply Chain_ Event. Occurrence. Logistics_ Location
0..1 Association	RequestedDeliveryPeriod	The requested Period for Delivery.	08B CC: Trade Delivery. Delivery. Event/Event. Occurrence. Date Time 08B BIE: Supply Chain_ Trade Delivery. Requested_ Delivery. Supply Chain_ Event/Supply Chain_ Event. Occurrence. Specified_ Period
0..1 Association	PromisedDeliveryPeriod	The promised Period for Delivery.	08B CC: Trade Delivery. Delivery. Event/Event. Occurrence. Date Time 08B BIE: Specified_ Period. Details
0..1 Association	EstimatedDeliveryPeriod	The estimated Period for Delivery.	08B CC: Trade Delivery. Delivery. Event/Event. Occurrence. Date Time 08B BIE: Specified_ Period. Details
0..1 Association	DeliveryParty	The party to whom the goods/services are delivered. Used in	08B CC: Trade Delivery. Ship To. Party 08B BIE: Supply Chain_ Trade Delivery. Ship To. Trade_ Party

DespatchLine

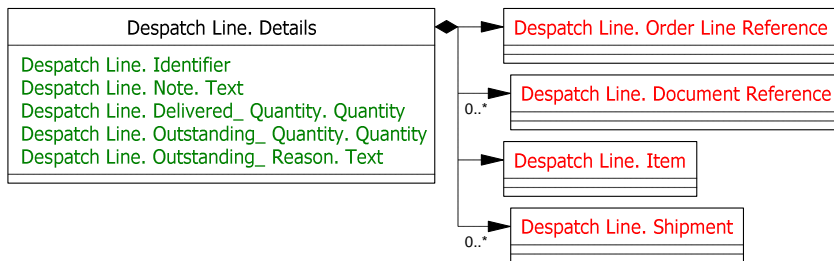

UBL Name **DespatchLine**
 Definition Information about a Despatch Line.

Crd	Short name	Requirement/Definition	Mapping/Comment
1..1	ID	Identifies the Despatch Line. A identifier for the individual line in the despatch advice.	08B CC: Trade Line Item. Identification. Identifier 08B BIE:

Crd	Short name	Requirement/Definition	Mapping/Comment
-----	------------	------------------------	-----------------

0.. 1	Note	Free-form text applying to the Despatch Line. This element may contain notes or any other similar information that is not contained explicitly in another structure. General note regarding the despach advice line	08B CC: Trade Line Item. Additional Information. Note/Note. Content. Text 08B BIE:
0.. 1	DeliveredQuantity	The quantity despatched. The quantity that is despatched in the line.	08B CC: Trade Line Item. Chargeable Unit. Quantity 08B BIE:
0.. 1	OutstandingQuantity	The quantity outstanding (which will follow in a later despatch).	08B CC: Trade Line Item. Chargeable Unit. Quantity 08B BIE:
0.. 1	OutstandingReason	The reason for the Outstanding Quantity.	08B CC: Trade Line Item. Additional Information. Note/Note. Content. Text 08B BIE:
1.. 1 Association	OrderLineReference	An association to Order Line Reference. To uniquely identify the line of the order that is being despatched.	08B CC: Trade Line Item. Specified. Trade Delivery/Trade Delivery. Referenced. Document 08B BIE: Referenced_ Document. Details
0.. unbound Association	DocumentReference	An association to Document Reference. Need not recognized.	08B CC: Trade Line Item. Specified. Trade Settlement/Trade Settlement. Referenced. Document 08B BIE: Referenced_ Document. Details
1.. 1 Association	Item	An association to Item. Detailed specification of the item covered with this despatch line.	08B CC: Trade Line Item. Specified. Product 08B BIE: Trade_ Product. Details
0.. unbound Association	Shipment	An association to Shipment. Provides details about the packaging unit in a shipment (box, pallet, crate, container.) in which the dispatch line item is packed. On line level this is not used to provide details about the shipment itself.	08B CC: Trade Line Item. Specified. Shipment *Required to be added to CCL 08B BIE:

Dimension

Dimension. Details
Dimension. Attribute Identifier. Identifier
Dimension. Measure
Dimension. Description. Text
Dimension. Minimum_ Measure. Measure
Dimension. Maximum_ Measure. Measure

UBL Name **Dimension**
Definition Information about a measurable dimension of an item.

Crd	Short name	Requirement/Definition	Mapping/Comment
1.. 1	AttributeID	An identifier for the attribute to which the measure applies.	08B CC: Dimension. Identification. Identifier 08B BIE: Spatial_ Dimension. Identification. Identifier
0.. 1	Measure	The measurement value.	08B CC: Dimension. Value. Measure 08B BIE: Spatial_ Dimension. Value. Measure
0.. unbound ed	Description	A description of the measurement attribute.	08B CC: Dimension. Description. Text 08B BIE: Spatial_ Dimension. Description. Text
0.. 1	MinimumMeasure	The minimum value in a range of measurement.	08B CC: Dimension. Value. Measure 08B BIE:
0.. 1	MaximumMeasure	The maximum value in a range of measurement.	08B CC: Dimension. Value. Measure 08B BIE:

DocumentDistribution

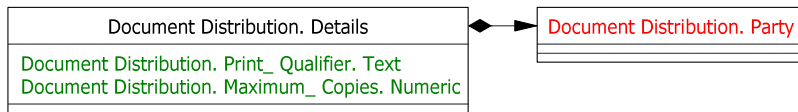

UBL Name **DocumentDistribution**
 Definition The details of the distribution of the document among business partners.

Crd	Short name	Requirement/Definition	Mapping/Comment
1..1	PrintQualifier	The access right for a Party to distribute the document.	08B CC: Document Distribution. Printing Rights. Text *Required to be added to CCL 08B BIE:
1..1	MaximumCopiesNumeric	Specifies the maximum number of copies of the document that the user can print.	08B CC: Document Distribution. Maximum Copies. Numeric *Required to be added to CCL 08B BIE:
1..1 Association	Party	Details of the Party who can access the document.	08B CC: Document Distribution. Distribution. Party *Required to be added to CCL 08B BIE: Trade_Party. Details

DocumentReference

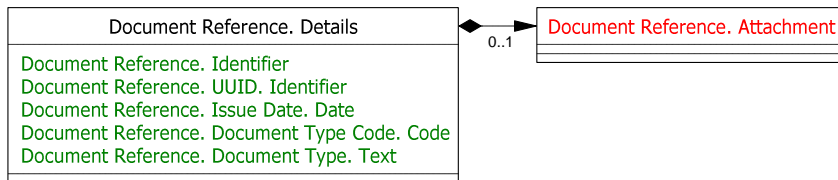

UBL Name **DocumentReference**
 Definition Information about a document referred to in another document.

Crd	Short name	Requirement/Definition	Mapping/Comment
1..1	ID	Identifies the document being referred to.	08B CC: Document. Identification. Identifier 08B BIE: Referenced_Document. Issuer Assigned_ Identification. Identifier
0..1	UUID	A universally unique identifier for an instance of this ABIE.	08B CC: Document. UUID. Identifier *Required to be added to CCL 08B BIE: Referenced_Document. Global_ Identification. Identifier
0..1	IssueDate	The date, assigned by the sender of the referenced document, on which the referenced document was issued.	08B CC: Document. Issue. Date Time 08B BIE: Referenced_Document. Issue. Date Time
0..1	DocumentTypeCode	The document type, expressed as a code.	08B CC: Document. Type. Code 08B BIE: Referenced_Document. Type. Code
0..1	DocumentType	The document type, expressed as text. Use in the absence of Document Type Code. Either Document Type or Document Type Code must be specified.	08B CC: Document. Description. Text 08B BIE:
0..1 Association	Attachment	An attached document, externally referred to, referred to in the MIME location, or embedded.	08B CC: Document. Reference. Document 08B BIE: Referenced_Document. Details

DocumentResponse

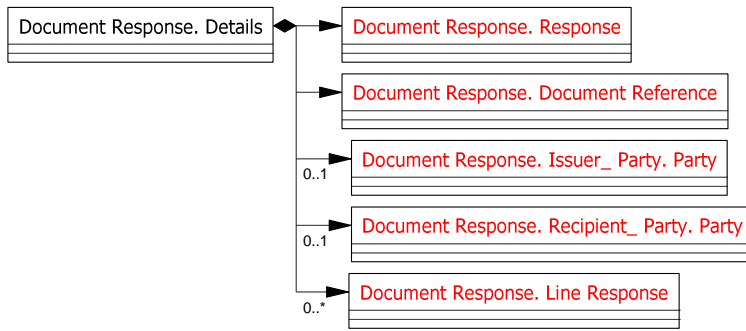

UBL Name		DocumentResponse	
Definition		Information about responses to a document (at the application level).	
1..1 Association	Response	The response to the document.	08B CC: Response. Content. Text 08B BIE:
1..1 Association	DocumentReference	An association to Document Reference.	08B CC: Response. Referenced. Document *Required to be added to CCL 08B BIE: Referenced_ Document. Details
0..1 Association	IssuerParty	The party who issued a document.	08B CC: Response. Issuer. Party *Required to be added to CCL 08B BIE: Trade_ Party. Details
0..1 Association	RecipientParty	The party for whom the document is intended.	08B CC: Response. Recipient. Party *Required to be added to CCL 08B BIE: Trade_ Party. Details
0.. unbound Association	LineResponse	Response to various lines in the document.	08B CC: Response. Detailed. Response *Required to be added to CCL 08B BIE:

ExchangeRate

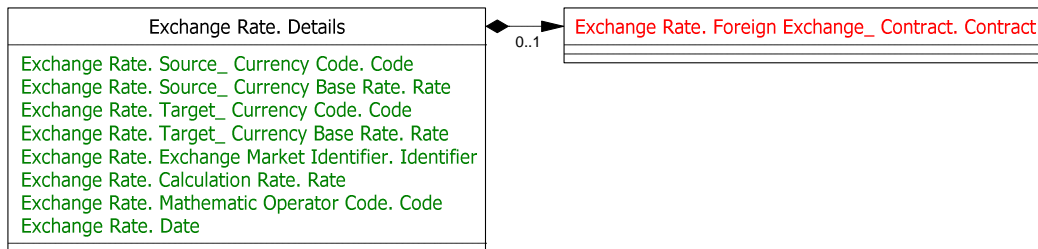

UBL Name		ExchangeRate	
Definition		Information about Exchange Rate.	

Crd	Short name	Requirement/Definition	Mapping/Comment
1..1	SourceCurrencyCode	The reference currency for the Exchange Rate; the currency from which the exchange is being made (CC Definition).	08B CC: Currency Exchange. Source Currency. Code 08B BIE: Trade_ Currency Exchange. Source Currency. Code
0..1	SourceCurrencyBaseRate	The unit base of the source currency for currencies with small denominations.	08B CC: Currency Exchange. Source Unit Basis. Numeric 08B BIE: Trade_ Currency Exchange. Source Unit Basis. Numeric
1..1	TargetCurrencyCode	The target currency for the Exchange Rate; the currency to which the exchange is being made (CC Definition).	08B CC: Currency Exchange. Target Currency. Code 08B BIE: Trade_ Currency Exchange. Target Currency. Code
0..1	TargetCurrencyBaseRate	The unit base of the target currency for currencies with small denominations.	08B CC: Currency Exchange. Target Unit Base. Numeric 08B BIE: Trade_ Currency Exchange. Target Unit Base. Numeric
0..1	ExchangeMarketID	Identifies the currency exchange market used as the source of the Exchange Rate.	08B CC: Currency Exchange. Market. Identifier 08B BIE: Trade_ Currency Exchange. Market. Identifier

0.. 1	CalculationRate	The factor applied to the source currency to calculate the target currency.	08B CC: Currency Exchange. Conversion. Rate 08B BIE: Trade_Currency Exchange. Conversion. Rate
-------	-----------------	---	---

Crd	Short name	Requirement/Definition	Mapping/Comment
0.. 1	MathematicOperatorCode	An identifier for whether the Calculation Rate should be used to multiply or to divide, expressed as a code.	08B CC: Currency Exchange. Mathematic Operator. Code *Required to be added to CCL 08B BIE:
0.. 1	Date	The date of the Exchange.	08B CC: Currency Exchange. Conversion Rate. Date Time 08B BIE: Trade_Currency Exchange. Conversion Rate. Date Time
0.. 1 Association	ForeignExchangeContract	An association to Foreign Exchange Contract.	08B CC: Currency Exchange. Applicable. Contract 08B BIE: Trade_Currency Exchange. Referenced. Referenced_Document

ExternalReference

External Reference. Details
External Reference. URI. Identifier External Reference. Document Hash. Text External Reference. Expiry Date. Date External Reference. Expiry Time. Time

UBL Name	ExternalReference
Definition	Information directly relating to an external reference i.e. a document stored at a remote location.

Crd	Short name	Requirement/Definition	Mapping/Comment
1.. 1	URI	The Uniform Resource Identifier (URI) that identifies where the external document is located.	08B CC: Document. Identification. Identifier 08B BIE: Referenced_Document. URI_Identifier. Identifier
0.. 1	DocumentHash	Specifies the hash code for the externally stored document.	08B CC: Document. Checksum. Numeric 08B BIE:
0.. 1	ExpiryDate	The date on which the document can no longer be found on the URI.	08B CC: Document. Effective. Period 08B BIE: Referenced_Document. Effective. Specified_Period
0.. 1	ExpiryTime	The time on which the document can no longer be found on the URI.	08B CC: Document. Effective. Period 08B BIE: Referenced_Document. Effective. Specified_Period

FinancialAccount

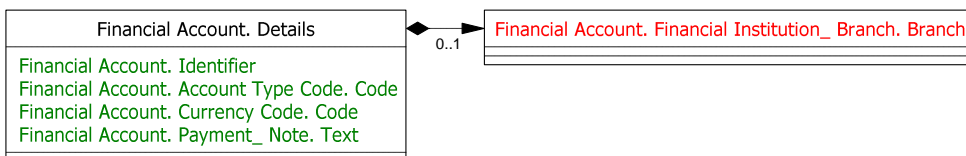

UBL Name	FinancialAccount
Definition	Information about a Financial Account.

Crd	Short name	Requirement/Definition	Mapping/Comment
0.. 1	ID	The identifier for the Financial Account; the Bank Account Number.	08B CC: Financial Account. Identification. Identifier 08B BIE: Creditor_Financial Account. IBAN_Identifier. Identifier Creditor_Financial Account. BBAN_Identifier. Identifier Creditor_Financial Account. UPIC_Identifier. Identifier Creditor_Financial Account. Proprietary_Identifier. Identifier
0.. 1	AccountTypeCode	The type of Financial Account, expressed as a code. Specifies the type of the account such as current	08B CC: Financial Account. Type. Code 08B BIE: Creditor_Financial Account. Type. Code

Crd	Short name	Requirement/Definition	Mapping/Comment
		account, cash account or using coded identification.	
0.. 1	CurrencyCode	The currency in which the Financial Account is held, expressed as a code.	08B CC: Financial Account. Currency. Code 08B BIE: Creditor_ Financial Account. Currency. Code
0.. unbounded	PaymentNote	Free-form text applying to the Payment to the owner of this account. Use one note per language.	08B CC: Financial Account. Payment Note. Text *Required to be added to CCL 08B BIE:
0.. 1 Association	FinancialInstitutionBranch	An association to Financial Institution Branch.	08B CC: Financial Account. Servicing. Financial Institution 08B BIE: Branch_ Financial Institution. Details

FinancialInstitution

Financial Institution. Details
Financial Institution. Identifier
Financial Institution. Name

UBL Name **FinancialInstitution**
Definition Information about a Financial Institution.

Crd	Short name	Requirement/Definition	Mapping/Comment
1.. 1	ID	The identifier for the Financial Institution expressed as a code; ISO 9362 BIC (Bank Identification Code) is recommended.	08B CC: Financial Institution. Identification. Identifier 08B BIE: Creditor_ Financial Institution. BIC. Identifier
0.. 1	Name	The name of the Financial Institution.	08B CC: Financial Institution. Name. Text 08B BIE: Creditor_ Financial Institution. Name. Text

HazardousItem

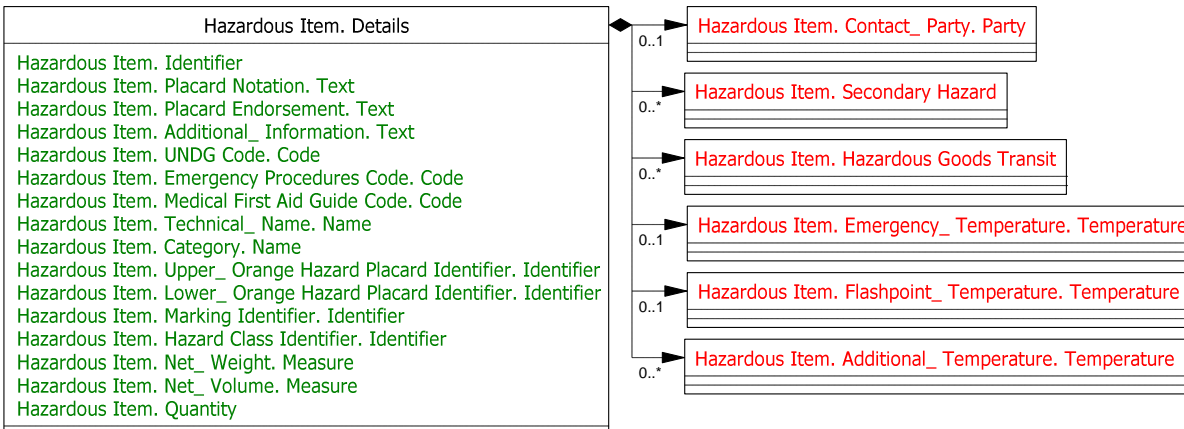

UBL Name **HazardousItem**
Definition Information about a Hazardous Item.

Crd	Short name	Requirement/Definition	Mapping/Comment
0.. 1	ID	The identifier for a Hazardous Item. Use to identify the Hazard Class applicable to the Item as defined by the relevant regulatory authority.	08B CC: Hazardous Material. Name. Text 08B BIE:
0.. 1	PlacardNotation	The placard notation corresponding to the hazard class of the hazardous commodity. Can also be the hazard identification number of the orange placard (upper part) required on the means of transport.	08B CC: Dangerous Goods. Upper Part Orange Hazard Placard. Identifier 08B BIE:

0.. 1	PlacardEndorsement	The placard endorsement that is to be shown on the shipping papers for the hazardous commodity. Can also be used for the number of the orange placard (lower part) required on the means of transport.	08B CC: Dangerous Goods. Lower Part Orange Hazard Placard. Identifier 08B BIE:
-------	--------------------	--	---

Crd	Short name	Requirement/Definition	Mapping/Comment
0.. 1	AdditionalInformation	Additional information about the hazardous substance. Can be used to specify information such as the type of regulatory requirements that apply to a description.	08B CC: Hazardous Material. Information. Text 08B BIE:
0.. 1	UNDGCode	The identifier assigned to transportable hazardous goods by the United Nations, expressed as a code.	08B CC: Hazardous Material. Type. Code 08B BIE:
0.. 1	EmergencyProceduresCode	The emergency procedures for the Hazardous Item, expressed as a code.	08B CC: Hazardous Material. Applicable. Hazard Rating/Hazard Rating. Value. Text 08B BIE:
0.. 1	MedicalFirstAidGuideCode	The identifier of a medical first aid guide that is relevant to specific hazardous goods, expressed as a code.	08B CC: Hazardous Material. Applicable. Hazard Rating/Hazard Rating. Value. Text 08B BIE:
0.. 1	TechnicalName	The full technical name of the specific hazardous substance.	08B CC: Dangerous Goods. Technical Name. Text 08B BIE:
0.. 1	CategoryName	The name of the category of hazard that applies to the Item.	08B CC: Hazardous Material. Applicable. Hazard Rating/Hazard Rating. Value. Text 08B BIE:
0.. 1	UpperOrangeHazardPlacardID	Specifies the identity number for the upper part of the orange hazard placard required on the means of transport.	08B CC: Hazardous Material. Applicable. Hazard Rating/Hazard Rating. Value. Text 08B BIE:
0.. 1	LowerOrangeHazardPlacardID	Specifies the identity number for the lower part of the orange hazard placard required on the means of transport.	08B CC: Hazardous Material. Applicable. Hazard Rating/Hazard Rating. Value. Text 08B BIE:
0.. 1	MarkingID	Identifies the marking of dangerous goods.	08B CC: Hazardous Material. Applicable. Hazard Rating/Hazard Rating. Value. Text 08B BIE:
0.. 1	HazardClassID	Identifies a hazard class applicable to dangerous goods as defined by the relevant regulation authority, such as the IMDG Class Number of the SOLAS Convention of IMO and the ADR/RID Class Number for the road/rail environment.	08B CC: Hazardous Material. Applicable. Hazard Rating/Hazard Rating. Value. Text 08B BIE:
0.. 1	NetWeightMeasure	The total net weight of hazardous goods; the weight of the goods plus packaging.	08B CC: Dangerous Goods. Net Weight. Measure 08B BIE:
0.. 1	NetVolumeMeasure	The volume of hazardous goods net of packaging and transport equipment.	08B CC: Hazardous Material. Net Volume. Measure *Required to be added to CCL 08B BIE:
0.. 1	Quantity	The quantity of goods that are hazardous.	08B CC: Hazardous Material. Contained. Quantity *Required to be added to CCL 08B BIE:
0.. 1 Association	ContactParty	Associates the Hazardous Item with details of an individual, group, or body that is the contact in case of hazard incident.	08B CC: Dangerous Goods. Emergency. Contact 08B BIE: Trade_ Party. Details
0.. unbound Association	SecondaryHazard	Associates the Hazardous Item with information about secondary hazards.	08B CC: Hazardous Material. Additional. Dangerous Goods *Required to be added to CCL 08B BIE:
0.. unbound Association	HazardousGoodsTransit	Associates the Hazardous Item with information about the transportation of hazardous goods.	08B CC: Dangerous Goods. Transported. Hazardous Material 08B BIE:
0.. 1 Association	EmergencyTemperature	Associates the Hazardous Item with the temperature at which emergency procedures apply during the handling of temperature-controlled hazardous goods.	08B CC: Hazardous Material. Emergency. Temperature *Required to be added to CCL 08B BIE:
0.. 1 Association	FlashpointTemperature	Associates the Hazardous Item with the lowest temperature at which the vapor of a combustible liquid can be made to ignite momentarily in air, known in hazardous goods procedures as the flashpoint.	08B CC: Dangerous Goods. Flashpoint Temperature. Measurement 08B BIE:
0.. unbound Association	AdditionalTemperature	Information providing details of temperatures relevant to the handling of hazardous goods.	08B CC: Hazardous Material. Additional. Temperature *Required to be added to CCL 08B BIE:

InvoiceLine

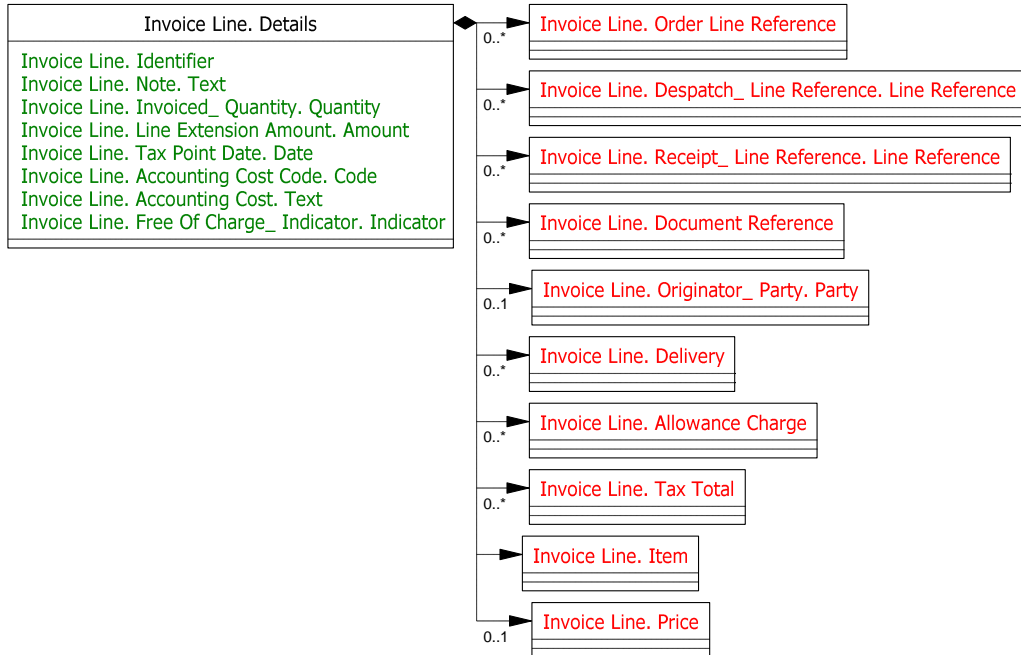

UBL Name **InvoiceLine**
 Definition Information about an Invoice Line.

Crđ	Short name	Requirement/Definition	Mapping/Comment
1.. 1	ID	Identifies the Invoice Line.	08B CC: Trade Line Item. Associated. Document/Document. Line. Identifier 08B BIE: Supply Chain_ Trade Line Item. Associated. Document Line_ Document/Document Line_ Document. Line. Identifier
0.. 1	Note	Free-form text applying to the Invoice Line. This element may contain notes or any other similar information that is not contained explicitly in another structure.	08B CC: Trade Line Item. Associated. Document/Document. Included. Note 08B BIE: Supply Chain_ Trade Line Item. Associated. Document Line_ Document/Document Line_ Document. Included. Note
0.. 1	InvoicedQuantity	The quantity (of Items) on the Invoice Line.	08B CC: Trade Line Item. Specified. Trade Delivery/Trade Delivery. Billed. Quantity 08B BIE: Supply Chain_ Trade Line Item. Specified. Supply Chain_ Trade Delivery/Supply Chain_ Trade Delivery. Billed. Quantity
1.. 1	LineExtensionAmount	The total amount for the Invoice Line, including Allowance Charges but net of taxes.	08B CC: Trade Line Item. Specified. Trade Settlement/Trade Settlement. Specified. Monetary Summation/Monetary Summation. Line Total. Amount 08B BIE: Supply Chain_ Trade Line Item. Specified. Supply Chain_ Trade Settlement/Supply Chain_ Trade Settlement. Specified. Trade Settlement_ Monetary Summation/Trade Settlement_ Monetary Summation. Line Total. Amount
0.. 1	TaxPointDate	The date of the Invoice Line, used to indicate the point at which tax becomes applicable. Use only for consolidated Invoices. Do not consolidate Invoices.	08B CC: Trade Line Item. Specified. Trade Settlement/Trade Settlement. Applicable. Tax/Tax. Tax Point. Date 08B BIE: Supply Chain_ Trade Line Item. Specified. Supply Chain_ Trade Settlement/Supply Chain_ Trade Settlement. Applicable. Trade_ Tax/ Trade_ Tax. Tax Point. Date

0.. 1	AccountingCostCode	The buyer's accounting code applied to the Invoice Line.	08B CC: Trade Line Item. Specified. Trade Settlement/Trade Settlement. Specified. Accounting Account/Accounting Account. Identification. Identifier
-------	--------------------	--	---

Crd	Short name	Requirement/Definition	Mapping/Comment
			08B BIE: supply Chain_ Trade Line Item. Specified. Supply Chain_ Trade Settlement/Supply Chain_ Trade Settlement. Specified. Trade_ Accounting Account/Trade_ Accounting Account. Identification. Identifier
0.. 1	AccountingCost	The buyer's accounting cost centre applied to the Invoice Line, expressed as text. Can be used for e.g project reference or other references that are needed for allocation of cost	08B CC: Trade Line Item. Specified. Trade Settlement/Trade Settlement. Specified. Accounting Account/Accounting Account. Cost Assignment Reference. Text 08B BIE: Supply Chain_ Trade Line Item. Specified. Supply Chain_ Trade Settlement/Supply Chain_ Trade Settlement. Specified. Trade_ Accounting Account/Trade_ Accounting Account. Cost Assignment Reference. Text
0.. 1	FreeOfChargeIndicator	Indicates whether the Invoice Line is Free Of Charge (default = false).	08B CC: Trade Line Item. Specified. Trade Agreement/Trade Agreement. Product Charge Free. Indicator 08B BIE: Supply Chain_ Trade Line Item. Specified. Supply Chain_ Trade Agreement/Supply Chain_ Trade Agreement. Product Charge Free. Indicator
0.. unbound Association	OrderLineReference	An association to Order Line Reference. Reference from the Invoice Line to an order and a specific line in the referred order.	08B CC: Trade Line Item. Specified. Trade Agreement/Trade Agreement. Referenced. Document 08B BIE: Supply Chain_ Trade Line Item. Specified. Supply Chain_ Trade Agreement/Supply Chain_ Trade Agreement. Buyer Order_ Referenced. Referenced_ Document
0.. unbound Association	DespatchLineReference	An associative reference to Despatch Line.	08B CC: Trade Line Item. Specified. Trade Delivery/ Trade Delivery. Referenced. Document 08B BIE: Supply Chain_ Trade Line Item. Specified. Supply Chain_ Trade Delivery/Supply Chain_ Trade Delivery. Despatch Advice_ Referenced. Referenced_ Document
0.. unbound Association	ReceiptLineReference	An associative reference to Receipt Line.	08B CC: Trade Line Item. Specified. Trade Delivery/Trade Delivery. Referenced. Document 08B BIE: Supply Chain_ Trade Line Item. Specified. Supply Chain_ Trade Delivery/Supply Chain_ Trade Delivery. Receiving Advice_ Referenced. Referenced_ Document
0.. unbound Association	DocumentReference	An association to Document Reference.	08B CC: Trade Line Item. Specified. Trade Settlement/Trade Settlement. Referenced. Document 08B BIE: Supply Chain_ Trade Line Item. Specified. Supply Chain_ Trade Settlement/Supply Chain_ Trade Settlement. Additional_ Referenced. Referenced_ Document
0.. 1 Association	OriginatorParty	The party who originated the Order to which the Invoice is related.	08B CC: Trade Line Item. Specified. Trade Agreement/Trade Agreement. Requisitioner. Party 08B BIE: Supply Chain_ Trade Line Item. Specified. Supply Chain_ Trade Agreement/Supply Chain_ Trade Agreement. Buyer_ Requisitioner. Trade_ Party
0.. unbound Association	Delivery	An association to Delivery.	08B CC: Trade Line Item. Specified. Trade Delivery 08B BIE: Supply Chain_ Trade Line Item.

0.. unbound Association	AllowanceCharge	An association to Allowance Charge.	Specified. Supply Chain_ Trade Delivery 08B CC: Trade Line Item. Specified. Trade Settlement/Trade Settlement. Specified. Allowance Charge 08B BIE: Supply Chain_ Trade Line Item. Specified. Supply Chain_ Trade Settlement/Supply Chain_ Trade Settlement. Specified. Trade_ Allowance Charge
0.. unbound Association	TaxTotal	An association to Tax Total.	08B CC: Trade Line Item. Specified. Trade Settlement/Trade Settlement. Applicable. Tax 08B BIE: Supply Chain_ Trade Line Item. Specified. Supply Chain_ Trade Settlement/Supply Chain_ Trade Settlement. Applicable. Trade_ Tax
1.. 1 Association	Item	An association to Item.	08B CC: Trade Line Item. Specified. Product 08B BIE: Supply Chain_ Trade Line Item. Specified. Trade_ Product
0.. 1 Association	Price	An association to Price.	08B CC: Trade Agreement. Product. Price 08B BIE: Supply Chain_ Trade Agreement. Agreed Price_ Product. Trade_ Price

ItemComparison

Item Comparison. Details
Item Comparison. Price. Amount
Item Comparison. Quantity

UBL Name	ItemComparison
Definition	Used to compare different items based on cost, quantity, or measurements.

Crd	Short name	Requirement/Definition	Mapping/Comment
1.. 1	PriceAmount	The price for the comparison quantity of the item. The item price based on a standardized unit.	08B CC: Product Comparison. Price. Amount *Required to be added to CCL 08B BIE:
1.. 1	Quantity	The quantity used for price comparison with other items. The unit on which the comparison price is based.	08B CC: Product Comparison. Compared. Quantity *Required to be added to CCL 08B BIE:

ItemIdentification

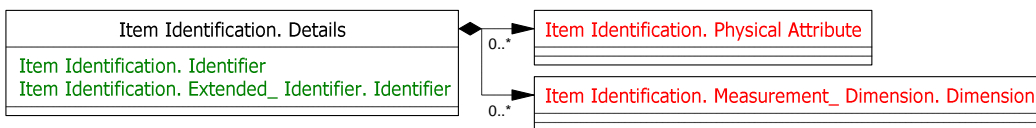

UBL Name	ItemIdentification
Definition	Information about item identification.

Crd	Short name	Requirement/Definition	Mapping/Comment
1.. 1	ID	An identifier for an item.	08B CC: Product. Identification. Identifier 08B BIE: Trade_ Product. Identification. Identifier
0.. 1	ExtendedID	An extended identifier for the item that identifies the item with specific properties, e.g., Item 123 = Chair / Item 123 Ext 45 = brown chair. Use for structured identification of an Item variant.	08B CC: Product. Identification. Identifier 08B BIE:
0.. unbound Association	PhysicalAttribute	An association to Physical Attribute. Use only to identify variance.	08B CC: Product. Applicable. Characteristic 08B BIE: Trade_ Product. Applicable. Product_ Characteristic
0.. unbound Association	MeasurementDimension	An association to Measurement Dimension. Used to give any kind of measurement related to the item identification.	08B CC: Product. Measurement. Dimension *Required to be added to CCL 08B BIE: Trade_ Product. Linear. Spatial_ Dimension

ItemInstance

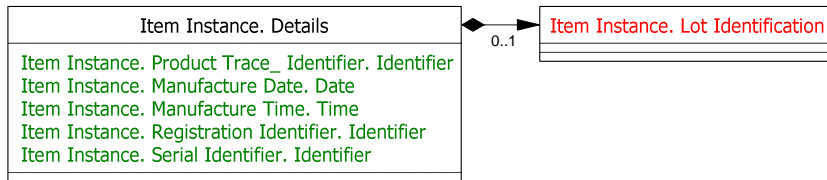

UBL Name **ItemInstance**
 Definition Information about a specific instance of an item.

Crd	Short name	Requirement/Definition	Mapping/Comment
0.. 1	ProductTraceID	An identifier used for tracing the item. E.g. the GS1's EPC (Electronic Product Code) used in RFID. See description.[1]	08B CC: Product Instance. Identification. Identifier 08B BIE: Trade_ Product Instance. Global Serial_ Identification. Identifier
0.. 1	ManufactureDate	The date of manufacture of the Item Instance. The date when the item was manufactured	08B CC: Product Instance. Production. Event/ Event. Occurrence. Date Time 08B BIE:
0.. 1	ManufactureTime	The time of manufacture of the Item Instance. The time when the item was manufactured	08B CC: Product Instance. Production. Event/ Event. Occurrence. Date Time 08B BIE:
0.. 1	RegistrationID	The registration identifier of the Item Instance. The registration ID for the item	08B CC: Product Instance. Certification Evidence. Document/Document. Item Identification. Identifier 08B BIE:
0.. 1	SerialID	The serial number of the Item Instance. A serial number for the item E.g., The GS1 (Formerly EAN) EPC Serialised Global Trade Item Identifier - SGTIN	08B CC: Product Instance. Identification. Identifier 08B BIE: Trade_ Product Instance. Supplier Assigned Serial_ Identification. Identifier OR Trade_ Product Instance. Manufacturer Assigned Serial_ Identification. Identifier
0.. 1 Association	LotIdentification	Associates the item instance with its lot identification (the identification that allows recall of the item if necessary). Information about the production lot of the item.	08B CC: Product Instance. Product. Batch * Required to be added to CCL 08B BIE: Trade_ Product Instance. Batch_ Identification. Identifier

ItemLocationQuantity

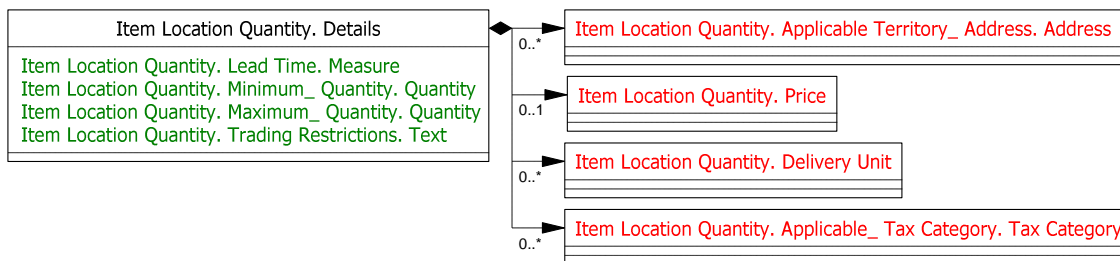

UBL Name **ItemLocationQuantity**
 Definition Information about the properties of an item as they relate to specific quantities and/or specific locations.

Crd	Short name	Requirement/Definition	Mapping/Comment
0.. 1	LeadTimeMeasure	The time taken from the time of order to the time of delivery for an item. The order lead time for the particular location.	08B CC: Item Location Quantity. Lead Time. Measure *Required to be added to CCL 08B BIE:
0.. 1	MinimumQuantity	The minimum quantity that can be ordered to qualify for a specific price. The minimum quantity that can be ordered from the particular location expressed in the units defined in the Item location quantity delivery unit.	08B CC: Item Location Quantity. Specified. Quantity *Required to be added to CCL 08B BIE:

0.. 1	MaximumQuantity	The maximum quantity that can be ordered to qualify for a specific price. The maximum quantity that can be ordered from the particular location expressed in the units defined in the Item location quantity delivery unit.	08B CC: Item Location Quantity. Specified. Quantity *Required to be added to CCL 08B BIE:
-------	-----------------	--	---

Crd	Short name	Requirement/Definition	Mapping/Comment
0.. unbound ed	TradingRestrictions	A description of trade restrictions that apply to the item or quantities of the item. Used to specify location specific trading restrictions.	08B CC: Item Location Quantity. Trading Restrictions. Text *Required to be added to CCL 08B BIE:
0.. unbound ed Association	ApplicableTerritoryAddress	An association to Territory (Address). Use to specify the area or place to which the Item Location Quantity values e.g. lead time, base price and base quantity, apply.	08B CC: Item Location Quantity. Applicable Territory. Address *Required to be added to CCL 08B BIE: Trade_ Address. Details
0.. 1 Association	Price	An association to Price. The price for the item at the specified locations	08B CC: Item Location Quantity. Specified. Price *Required to be added to CCL 08B BIE: Trade_ Price. Details
0.. unbound ed Association	DeliveryUnit	An association to Delivery Unit. Used to specify delivery units of an item that are specific to the location.	08B CC: Item Location Quantity. Specified. Delivery *Required to be added to CCL 08B BIE:
0.. unbound ed Association	ApplicableTaxCategory	An association to Tax Category. Used to specify location specific tax categories.	08B CC: Item Location Quantity. Applicable. Tax *Required to be added to CCL 08B BIE: Trade_ Tax. Details

ItemPropertyGroup

Item Property Group. Details
Item Property Group. Identifier
Item Property Group. Name

UBL Name **ItemPropertyGroup**
Definition Information about sets of classifications (or groups) of Item Properties.

Crd	Short name	Requirement/Definition	Mapping/Comment
1.. 1	ID	An identifier for the Item Property Group.	08B CC: Characteristic. Identification. Identifier 08B BIE:
0.. 1	Name	The name of the Item Property Group.	08B CC: Characteristic. Description. Text 08B BIE:

ItemProperty

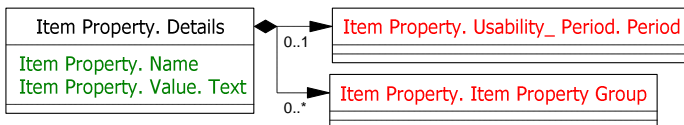

UBL Name **ItemProperty**
Definition Information about specific Item Properties.

Crd	Short name	Requirement/Definition	Mapping/Comment
1.. 1	Name	The name of the Item Property.	08B CC: Goods Characteristic. Description. Text 08B BIE:
1.. 1	Value	The Item Property value.	08B CC: Goods Characteristic. Feature. Measure 08B BIE:
0.. 1 Association	UsabilityPeriod	The period for which the Item Property is valid.	08B CC: Goods Characteristic. Usability. Period *Required to be added to CCL 08B BIE: Specified_Period. Details
0.. unbound ed Association	ItemPropertyGroup	An association to Item Property Group. Use to specify whether the Item Properties belong to a particular category.	08B CC: Goods Characteristic. Specified. Characteristic 08B BIE:

Item

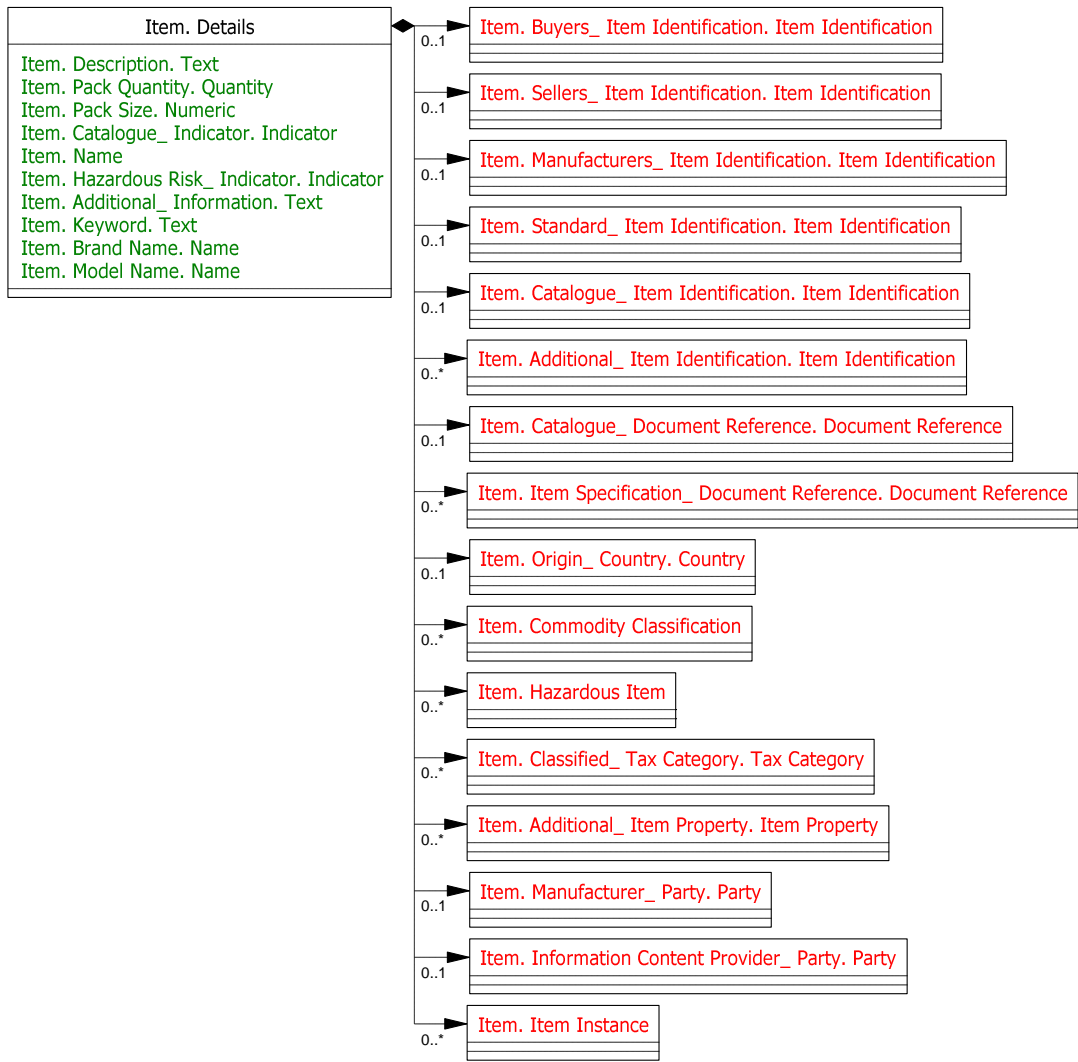

UBL Name **Item**
 Definition Information directly relating to an item.

Crd	Short name	Requirement/Definition	Mapping/Comment
0.. unbound	Description	Free-form field that can be used to give a text description of the item. A detailed description of the item. Use one description per language.	08B CC: Product. Description. Text 08B BIE: Trade_ Product. Description. Text
0.. 1	PackQuantity	The unit packaging quantity. The prepacking the article is available in, and which contains the number of unit described in PackSizeNumeric. Unit description to PackQuantity. The value should be a valid UOM code like CS for case.	08B CC: Product. Applicable. Packaging/ Packaging. Total Unit. Quantity 08B BIE: Trade_ Package. Item. Quantity / Supply Chain_ Trade Delivery. Product_ Unit. Quantity
0.. 1	PackSizeNumeric	The number of items in a pack. The number of units in a package of the article.	08B CC: Product. Applicable. Packaging / Trade Delivery. Unit. Quantity 08B BIE: Trade_ Product. Applicable. Supply Chain_ Packaging / Supply Chain_ Trade Delivery. Per Package_ Unit. Quantity
0.. 1	CatalogueIndicator	Indicates whether the item was ordered from a Catalogue (true) or not (false). Used documents like invoice or order to Indicates whether the item was ordered from a Catalogue (true) or not (false). Not used in catalogue	08B CC: Product. Catalogue. Indicator *Required to be added to CCL 08B BIE:

0.. 1	Name	A short name optionally given to an item, such as a name from a Catalogue, as distinct from a description. A short name for the item.	08B CC: Product. Name. Text 08B BIE: Trade_ Product. Name. Text
0.. 1	HazardousRiskIndicator	Indicates whether the item as delivered is hazardous.	08B CC: Product. Hazardous Risk. Indicator *Required to be added to CCL 08B BIE:
0.. 1	AdditionalInformation	Provides more details of the item (e.g., the URL of a relevant web page). Used to provide textual additional information of	08B CC: Trade Line Item. Additional Information. Note / Trade Line Item. Additional Information. Note

Crđ	Short name	Requirement/Definition	Mapping/Comment
		the item.	08B BIE: Supply Chain_ Trade Line Item. Additional Information. Note / Supply Chain_ Trade Line Item. Additional Information. Note
0.. unbound	Keyword	A Seller Party-defined search string for the item. Also could be synonyms for identifying the item. Used to specify searchable keywords and/or synonyms for the Item.	08B CC: Product. Keyword. Text *Required to be added to CCL 08B BIE:
0.. unbound	BrandName	Brand name for the item. Used to state the brand name for the item.	08B CC: Product. Name. Text 08B BIE:
0.. unbound	ModelName	Model name for the item. Used to specify the model name for the item.	08B CC: Product. Name. Text 08B BIE:
0.. 1 Association	BuyersItemIdentification	Associates the item with its identification according to the buyer's system. Used to specify the ID used by the buyer when ordering goods. Can be copied into the invoice to facilitate matching.	08B CC: Product. Identification. Identifier 08B BIE: Trade_ Product. Buyer Assigned_ Identification. Identifier
0.. 1 Association	SellersItemIdentification	Associates the item with its identification according to the seller's system. The seller's ID for the item.	08B CC: Product. Identification. Identifier 08B BIE: Trade_ Product. Seller Assigned_ Identification. Identifier
0.. 1 Association	ManufacturersItemIdentification	Associates the item with its identification according to the manufacturer's system. The item ID used by the manufacturer of the item.	08B CC: Product. Identification. Identifier 08B BIE: Trade_ Product. Manufacturer Assigned_ Identification. Identifier
0.. 1 Association	StandardItemIdentification	Associates the item with its identification according to a standard system. Standardized ID for the item	08B CC: Product. Identification. Identifier 08B BIE: Trade_ Product. Global_ Identification. Identifier
0.. 1 Association	CatalogueItemIdentification	Associates the item with its identification according to a cataloguing system. The item ID used in the catalogue on which the order is based.	08B CC: Product. Identification. Identifier 08B BIE: Trade_ Product. Identification. Identifier
0.. unbound Association	AdditionalItemIdentification	Associates the item with other identification means. Any additional identifiers for the item that are relevant.	08B CC: Product. Identification. Identifier 08B BIE: Trade_ Product. Identification. Identifier
0.. 1 Association	CatalogueDocumentReference	An associative reference to Catalogue. Reference to the catalogue on which the order line is based and from which the Catalogue Item Identification is taken.	08B CC: Product. Reference. Document 08B BIE: Supply Chain_ Trade Agreement. Additional_ Referenced. Referenced_ Document
0.. unbound Association	ItemSpecificationDocumentReference	An associative reference to a document providing Item specification. Reference to a document containing Item specifications. Use to specify Item Specification Documents other than pictures.	08B CC: Product. Reference. Document 08B BIE: Supply Chain_ Trade Agreement. Additional_ Referenced. Referenced_ Document
0.. 1 Association	OriginCountry	Associates the item with its country of origin. Used to provide the country from which the item has its origin. Commonly used in cross border trade for statistical and customs purposes.	08B CC: Product. Origin. Country 08B BIE: Trade_ Product. Origin. Trade_ Country
0.. unbound Association	CommodityClassification	Associates the item with its classification(s) according to a commodity classifying system.	08B CC: Product. Designated. Classification 08B BIE: Trade_ Product. Designated. Product_ Classification
0.. unbound Association	HazardousItem	Associates the item with its hazardous item information. Provides detail of the classification and nature of a hazardous item.	08B CC: Product. Contained. Hazardous Material *Required to be added to CCL 08B BIE:
0.. unbound Association	ClassifiedTaxCategory	Classifies the item using one or more categories of taxes. Used to provide information about in what tax category the item is.	08B CC: Trade Settlement. Applicable. Tax. Type. Code 08B BIE: Supply Chain_ Trade Settlement. Applicable. Trade_ Tax. Type. Code
0.. unbound Association	AdditionalItemProperty	Associates the item with a set of additional properties. Use for structured specification of Item Properties. Any properties of the item that can not be specified in other elements.	08B CC: Product. Applicable. Goods Characteristic 08B BIE: Trade_ Product. Applicable. Product_ Characteristic
0.. 1 Association	ManufacturerParty	Associates the item with its manufacturer. Information about the manufacturer of the Item	08B CC: Product. Manufacturer. Party 08B BIE: Trade_ Product. Manufacturer. Trade_ Party
0.. 1	InformationContentProvider	Associates the item with the party responsible for	08B CC: Product. Information Content Provider.

Association	Party	the its specification. See description.	Party *Required to be added to CCL 08B BIE: Trade_Party. Details
0.. unbound ed Association	ItemInstance	An association to Item Instance. Specifications of a particular item.	08B CC: Product. Individual. Product Instance 08B BIE: Trade_Product Instance. Details

Language

Language. Details
Language. Identifier Language. Name Language. Locale Code. Code

UBL Name

Language

Definition

Information about Language.

Crd	Short name	Requirement/Definition	Mapping/Comment
0.. 1	ID	An identifier for a language, expressed as a code.	08B CC: Language. Identification. Identifier * Required to be added to CCL 08B BIE:
0.. 1	Name	The name of the language.	08B CC: Language. Name. Text * Required to be added to CCL 08B BIE:
0.. 1	LocaleCode	The locale where the language is used, expressed as a code.	08B CC: Language. Locale. Code * Required to be added to CCL 08B BIE:

LineItem

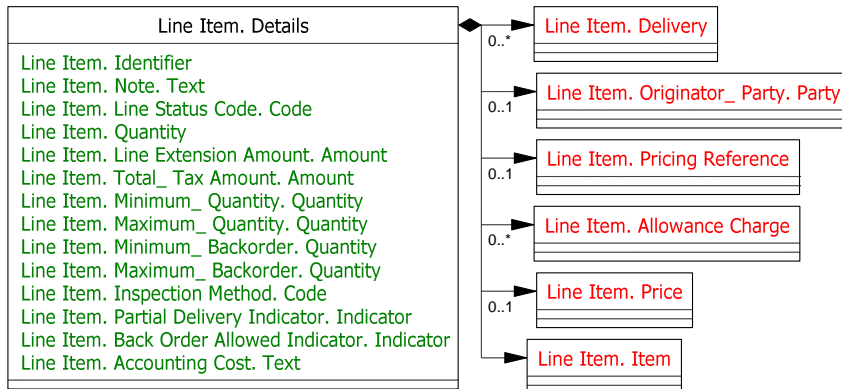

UBL Name

Lineitem

Definition

Information about a Line Item.

Crd	Short name	Requirement/Definition	Mapping/Comment
1.. 1	ID	Identifies the Line Item assigned by the buyer. Use to specify Line Number.	08B CC: Trade Line Item. Identification. Identifier 08B BIE: Supply Chain_Trade Line Item. Identification. Identifier
0.. 1	Note	Free-form text applying to the Line Item. This element may contain notes or any other similar information that is not contained explicitly in another structure. Restrict this one out	08B CC: Trade Line Item. Additional Information. Note 08B BIE: Supply Chain_Trade Line Item. Additional Information. Note
0.. 1	LineStatusCode	Identifies the status of the Line with respect to its original state. Used on Order response. Not used in Order	08B CC: Trade Line Item. Associated. Document. Line Status. Code 08B BIE: Supply Chain_Trade Line Item. Associated. Document Line_Document. Line Status. Code
1.. 1	Quantity	The quantity of Items for the Line Item. The quantity for the order line.	08B CC: Trade Delivery. Billed. Quantity 08B BIE: Supply Chain_Trade Delivery. Billed.

Crđ	Short name	Requirement/Definition	Mapping/Comment
			Quantity
0.. 1	LineExtensionAmount	The total amount for the Line Item, including Allowance Charges but net of taxes. The expected line amount excluding VAT but inclusive of other charges, allowances and taxes.	08B CC: Trade Settlement. Payment. Amount 08B BIE: Supply Chain_ Trade Settlement. Payment. Amount
0.. 1	TotalTaxAmount	The total tax amount for the Line Item. The total amounts of taxes on the line.	08B CC: Trade Settlement. Total Tax. Amount 08B BIE: Supply Chain_ Trade Settlement. Total Tax. Amount
0.. 1	MinimumQuantity	The minimum quantity for the Item on the Line.	08B CC: Trade Line Item. Chargeable Unit. Quantity 08B BIE:
0.. 1	MaximumQuantity	The maximum quantity for the Item on the Line.	08B CC: Trade Line Item. Chargeable Unit. Quantity 08B BIE:
0.. 1	MinimumBackorderQuantity	The minimum back order quantity (where back order is allowed).	08B CC: Trade Line Item. Chargeable Unit. Quantity 08B BIE:
0.. 1	MaximumBackorderQuantity	The maximum back order quantity (where back order is allowed).	08B CC: Trade Line Item. Chargeable Unit. Quantity 08B BIE:
0.. 1	InspectionMethodCode	Inspection requirements for a Line Item, expressed as a code.	08B CC: Product.Reference. Document. Category. Code 08B BIE: Trade_ Product. Inspection_ Reference. Referenced_ Document. Category. Code
0.. 1	PartialDeliveryIndicator	Indicates whether a partial delivery is allowed. Use to indicate whether the Items may delivered in more than one delivery. If Partial Delivery Indicator = True, more than one delivery is allowed.	08B CC: Trade Line Item. Partial Delivery. Indicator *Required to be added to CCL 08B BIE:
0.. 1	BackOrderAllowedIndicator	Indicates whether back order is allowed. Use to indicate whether the Items may be placed on back order. If Back Order Indicator = True, Items may be placed on back order.	08B CC: Trade Delivery. Partial Delivery Allowed. Indicator 08B BIE: Supply Chain_ Trade Delivery. Partial Delivery Allowed. Indicator
0.. 1	AccountingCost	The buyer's accounting cost centre applied to the Line Item, expressed as text. Use in the absence of a Line Item Accounting Cost Code.	08B CC: Trade Line Item. Account. Accounting Account/Accounting Account. Cost Assignment Reference. Text 08B BIE: Supply Chain_ Trade Line Item. Specified. Supply Chain_ Trade Settlement/Supply Chain_ Trade Settlement. Specified. Trade_ Accounting Account/Trade_ Accounting Account. Name. Text
0.. unbound Association	Delivery	An association to Delivery. Use to specify different Delivery times and/or locations at Order Line level.	08B CC: Trade Line Item. Specified. Trade Delivery 08B BIE: Supply Chain_ Trade Line Item. Specified. Supply Chain_ Trade Delivery
0.. 1 Association	OriginatorParty	The party who originated Order. Use to specify the original requester of the Line Item (rather than the Buyer placing the Order).	08B CC: Trade Line Item. Specified. Trade Agreement/Trade Agreement. Buyer. Party 08B BIE: Trade_ Party. Details
0.. 1 Association	PricingReference	An association to Pricing Reference.	08B CC: Trade Line Item. Unit. Price 08B BIE:
0.. unbound Association	AllowanceCharge	An association to Allowance Charge.	08B CC: Trade Line Item. Applicable. Allowance Charge 08B BIE: Supply Chain_ Trade Agreement. Applicable. Trade_ Allowance Charge
0.. 1 Association	Price	An association to Price.	08B CC: Trade Line Item. Unit. Price 08B BIE: Supply Chain_ Trade Agreement. Net Price_ Product. Trade_ Price
1.. 1 Association	Item	An association to Item.	08B CC: Trade Line Item. Specified. Product 08B BIE: Supply Chain_ Trade Line Item. Specified. Trade_ Product

LineReference

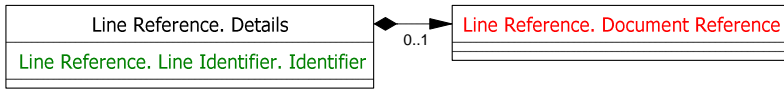

UBL Name **LineReference**
 Definition Reference to a Line on a document.

Crd	Short name	Requirement/Definition	Mapping/Comment
1..1	LineID	Identifies the Line on the referenced document.	08B CC: Document. Line. Identifier 08B BIE: Referenced_ Document. Line. Identifier
0..1 Association	DocumentReference	An association to Document Reference.	08B CC: Trade Line Item. Associated. Document 08B BIE: Referenced_ Document. Details

LineResponse

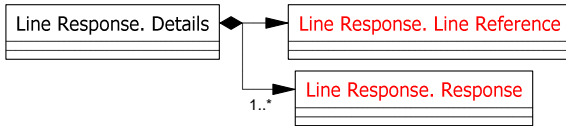

UBL Name **LineResponse**
 Definition A response to a Line in a Document.

1..1 Association	LineReference	An association to Line Reference.	08B CC: Response. Identification. Identifier 08B BIE: Referenced_ Document. Details
1.. unbound Association	Response	An association to Response.	08B CC: Response. Details 08B BIE:

LocationCoordinate

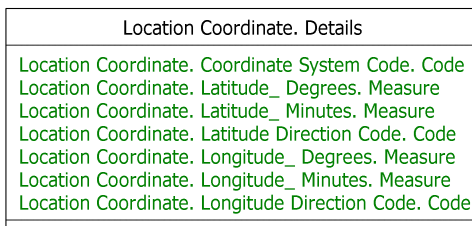

UBL Name **LocationCoordinate**
 Definition Information about physical (geographical) location.

Crd	Short name	Requirement/Definition	Mapping/Comment
1..1	CoordinateSystemCode	An identifier for the location system used.	08B CC: Geographical Coordinate. System. Identifier 08B BIE: Geographical Coordinate. System. Identifier
1..1	LatitudeDegreesMeasure	The measure of latitude in degrees.	08B CC: Geographical Coordinate. Latitude. Measure 08B BIE: Geographical Coordinate. Latitude. Measure
1..1	LatitudeMinutesMeasure	The measure of latitude in minutes.	08B CC: Geographical Coordinate. Latitude. Measure 08B BIE: Geographical Coordinate. Latitude. Measure
1..1	LatitudeDirectionCode	The direction of latitude measurement from the equator.	08B CC: Geographical Coordinate. Latitude Direction. Indicator 08B BIE: Geographical Coordinate. Latitude Direction. Indicator
1..1	LongitudeDegreesMeasure	The measure of longitude in degrees.	08B CC: Geographical Coordinate. Longitude. Measure 08B BIE: Geographical Coordinate. Longitude. Measure

Crd	Short name	Requirement/Definition	Mapping/Comment
1..1	LongitudeMinutesMeasure	The measure of longitude in minutes.	08B CC: Geographical Coordinate. Longitude. Measure 08B BIE: Geographical Coordinate. Longitude. Measure
1..1	LongitudeDirectionCode	The direction of longitude measurement from the meridian.	08B CC: Geographical Coordinate. Latitude Direction. Indicator 08B BIE: Geographical Coordinate. Latitude Direction. Indicator

Location

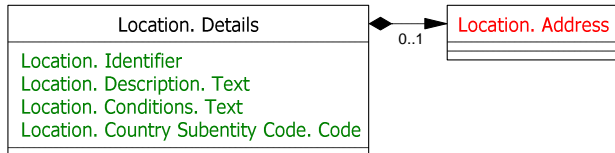

UBL Name **Location**
 Definition Information about a location.

Crd	Short name	Requirement/Definition	Mapping/Comment
0..1	ID	The unique identifier for the location, e.g., the GS1 (Formerly EAN) Global Location Number, GLN	08B CC: Location. Identification. Identifier 08B BIE: Trade_Location. Identification. Identifier
0..1	Description	The description or name of the location.	08B CC: Location. Description. Text 08B BIE:
0..1	Conditions	Conditions describing the location.	08B CC: 08B BIE:
0..1	CountrySubentityCode	The territorial division of a country, such as a county or state, expressed as a code. Coded identification of a country region or area other than postal codes.	08B CC: Location. Country Sub-Division. Identifier 08B BIE:
0..1 Association	Address	Association to the address of the location.	08B CC: Location. Physical. Address 08B BIE: Trade_Address. Details

LotIdentification

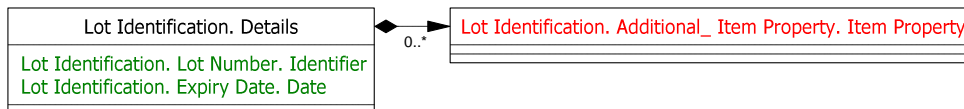

UBL Name **LotIdentification**
 Definition Information about a lot (of Item Instances).

Crd	Short name	Requirement/Definition	Mapping/Comment
0..1	LotNumberID	Identifies the lot. Identifier for a production lot in which the items in the item line where produces.	08B CC: Product Instance. Identification. Identifier 08B BIE: Trade_Product Instance. Batch_ Identification. Identifier
0..1	ExpiryDate	The expiry date of the lot. Used to express the expiry date of the item or items in the line instance.	08B CC: Product Instance. Expiry. Date Time 08B BIE: Trade_Product Instance. Expiry. Date Time
0.. unbound Association	AdditionalItemProperty	An association to Additional Item Property. Use for structured specification of Item Properties.	08B CC: Product Instance. Product. Characteristic 08B BIE: Trade_Product Instance. Product. Product_Characteristic

MonetaryTotal

Monetary Total. Details
Monetary Total. Line Extension Amount. Amount
Monetary Total. Tax Exclusive Amount. Amount
Monetary Total. Tax Inclusive Amount. Amount
Monetary Total. Allowance Total Amount. Amount
Monetary Total. Charge Total Amount. Amount
Monetary Total. Prepaid Amount. Amount
Monetary Total. Payable_ Rounding Amount. Amount
Monetary Total. Payable_ Amount. Amount

UBL Name **MonetaryTotal**
Definition Information about Monetary Totals.

Crd	Short name	Requirement/Definition	Mapping/Comment
1..1	LineExtensionAmount	The total of Line Extension Amounts net of tax and settlement discounts, but inclusive of any applicable rounding amount.	08B CC: Monetary Summation. Line Total. Amount 08B BIE: Trade Settlement_ Monetary Summation. Line Total. Amount
0..1	TaxExclusiveAmount	The total amount exclusive of taxes.	08B CC: Monetary Summation. Line Total. Amount 08B BIE:
0..1	TaxInclusiveAmount	The total amount inclusive of taxes.	08B CC: Monetary Summation. Line Total. Amount 08B BIE: Trade Settlement_ Monetary Summation. Grand Total. Amount
0..1	AllowanceTotalAmount	The total amount of all allowances.	08B CC: Monetary Summation. Allowance Total. Amount 08B BIE: Trade Settlement_ Monetary Summation. Allowance Total. Amount
0..1	ChargeTotalAmount	The total amount of all charges.	08B CC: Monetary Summation. Charge Total. Amount 08B BIE: Trade Settlement_ Monetary Summation. Charge Total. Amount
0..1	PrepaidAmount	The total prepaid amount.	08B CC: Monetary Summation. Total Prepaid. Amount 08B BIE: Trade Settlement_ Monetary Summation. Total Prepaid. Amount
0..1	PayableRoundingAmount	The rounding amount (positive or negative) added to the calculated Line Extension Total Amount to produce the rounded Line Extension Total Amount. The rounding amount (positive or negative) added to the invoice to produce a rounded MonetaryTotal/PayableAmount	08B CC: Monetary Summation. Rounding. Amount 08B BIE: Trade Settlement_ Monetary Summation. Rounding. Amount
1..1	PayableAmount	The total amount to be paid.	08B CC: Monetary Summation. Grand Total. Amount 08B BIE: Trade Settlement_ Monetary Summation. Grand Total. Amount

OrderLineReference

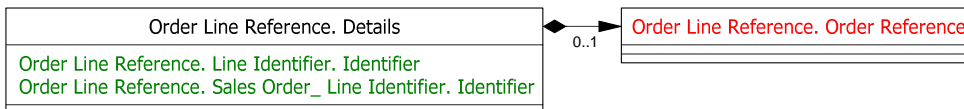

UBL Name **OrderLineReference**
Definition Information about an Order Line Reference.

Crd	Short name	Requirement/Definition	Mapping/Comment
1..1	LineID	Identifies the referenced Order Line assigned by the buyer.	08B CC: Document. Line. Identifier 08B BIE: Referenced_ Document. Line. Identifier
0..1	SalesOrderLineID	Identifies the referenced Order Line assigned by the seller.	08B CC: Document. Line. Identifier 08B BIE:
0..1 Association	OrderReference	An association to Order Reference.	08B CC: Trade Line Item. Associated. Document 08B BIE: Referenced_ Document. Details

OrderLine

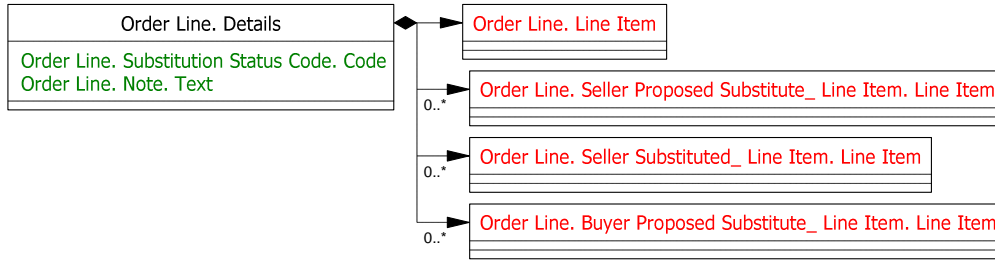

UBL Name **OrderLine**
 Definition Information about an Order Line.

Crd	Short name	Requirement/Definition	Mapping/Comment
0.. 1	SubstitutionStatusCode	A code indicating the substitution status of the Order Line. Order Line may indicate that a substitute is proposed by the buyer or by the seller (in Order Response) or that a substitution has been made by the seller (in Order Response). The ability to specify the status of a given order line in relation.	08B CC: Trade Line Item. Type Extension. Code 08B BIE:
0.. 1	Note	Free-form text applying to the Order Line. This element may contain notes or any other similar information that is not contained explicitly in another structure. Is to capture any free form description related to the order line as a whole.	08B CC: Trade Line Item. Associated. Document/Document. Included. Note 08B BIE: Document Line_ Document. Included. Note
1.. 1 Association	LineItem	An association to Line Item. To specify details about the Item being ordered.	08B CC: Trade Line Item. Specified. Product 08B BIE: Supply Chain_ Trade Line Item. Details / Supply Chain_ Trade Agreement. Details
0.. unbound Association	SellerProposedSubstituteLineItem	Substitute Line Items proposed by the seller (in Order Response). Only used in order response	08B CC: Trade Line Item. Substitute. Trade Line Item *Required to be added to CCL 08B BIE: Supply Chain_ Trade Line Item. Details / Supply Chain_ Trade Agreement. Details
0.. unbound Association	SellerSubstitutedLineItem	Item(s) replaced by the seller. The original ordered quantity and pricing may be different from the substituted item. However, when an item is substituted by the seller, it is assumed that other information, such as shipment details, will be the same. Only used in order response	08B CC: Trade Line Item. Substitute. Trade Line Item *Required to be added to CCL 08B BIE: Supply Chain_ Trade Line Item. Details / Supply Chain_ Trade Agreement. Details
0.. unbound Association	BuyerProposedSubstituteLineItem	Possible alternatives, proposed by the buyer, to the Line Item. Not used.	08B CC: Trade Line Item. Substitute. Trade Line Item *Required to be added to CCL 08B BIE: Supply Chain_ Trade Line Item. Details / Supply Chain_ Trade Agreement. Details

PartyIdentification



UBL Name **PartyIdentification**
 Definition Information about a party's identification.

Crd	Short name	Requirement/Definition	Mapping/Comment
1.. 1	ID	Identifies a party. Use in the absence of or in addition to Party Name. Use an identifier known to the document recipient. e.g., the GS1 (Formerly EAN) Global Location Number, GLN.	08B CC: Party. Identification. Identifier 08B BIE: Trade_ Party. Identification. Identifier

PartyLegalEntity

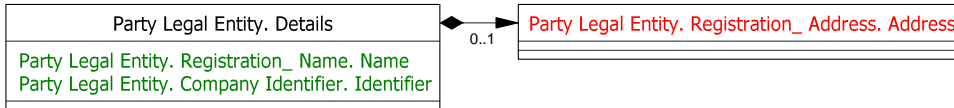

UBL Name **PartyLegalEntity**

Definition Information directly relating to the legal registration that is applicable to a party.

Crd	Short name	Requirement/Definition	Mapping/Comment
0.. 1	RegistrationName	The name of a party as registered with the legal authority. The name of the Party registered as a legal entity with the relevant company register.	08B CC: Registration. Identification. Identifier 08B BIE:
1.. 1	CompanyID	Identifies a company as registered with the company registration scheme. Use the identifier assigned to the Party by the national company register. Use the Data Type attributes to identify the issuer.	08B CC: Registration. Licence. Identifier 08B BIE: Legal_ Registration. Identification. Identifier
0.. 1 Association	RegistrationAddress	Associates with the registered address of the party within a Corporate Registration Scheme. Use only if the legally registered address differs from Postal Address.	08B CC: Organization. Postal. Address 08B BIE: Legal_ Organization. Postal. Trade_ Address

PartyName

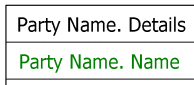

UBL Name **PartyName**
 Definition Information about a party's name.

Crd	Short name	Requirement/Definition	Mapping/Comment
1..1	Name	The name of the party. Use in the absence of or in addition to Party Identifier.	08B CC: Party. Name. Text 08B BIE: Trade_Party. Name. Text

PartyTaxScheme

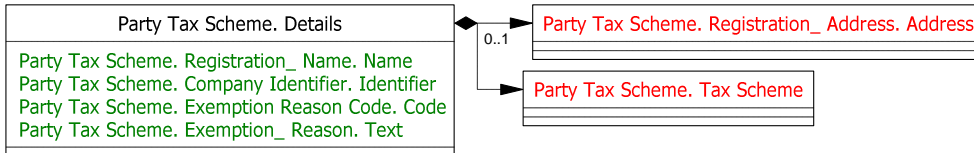

UBL Name **PartyTaxScheme**
 Definition Information about a party's Tax Scheme.

Crd	Short name	Requirement/Definition	Mapping/Comment
0..1	RegistrationName	The official name of the party as registered with the relevant fiscal authority. The name of the Party registered as a fiscal entity with the relevant tax authority.	08B CC: Organization. Specified. VAT Registration 08B BIE:
0..1	CompanyID	The identifier assigned for tax purposes to a party by the taxation authority.	08B CC: Organization. Specified. VAT Registration 08B BIE: Tax_Registration. Identification. Identifier
0..1	ExemptionReasonCode	A reason for a party's exemption from tax, expressed as a code.	08B CC: Tax. Exemption Reason. Code 08B BIE:
0..1	ExemptionReason	A reason for a party's exemption from tax, expressed as text. Use in the absence of an Exemption Reason Code.	08B CC: Tax. Exemption Reason. Text 08B BIE:
0..1 Association	RegistrationAddress	An association to Registered Address (for tax purposes). Use only if the tax registered address differs from Postal Address.	08B CC: Registration. Details 08B BIE: Tax_Registration. Associated. Registered_Tax
1..1 Association	TaxScheme	An association to Tax Scheme.	08B CC: Registration. Associated. Tax 08B BIE: Trade_Tax. Details

Party

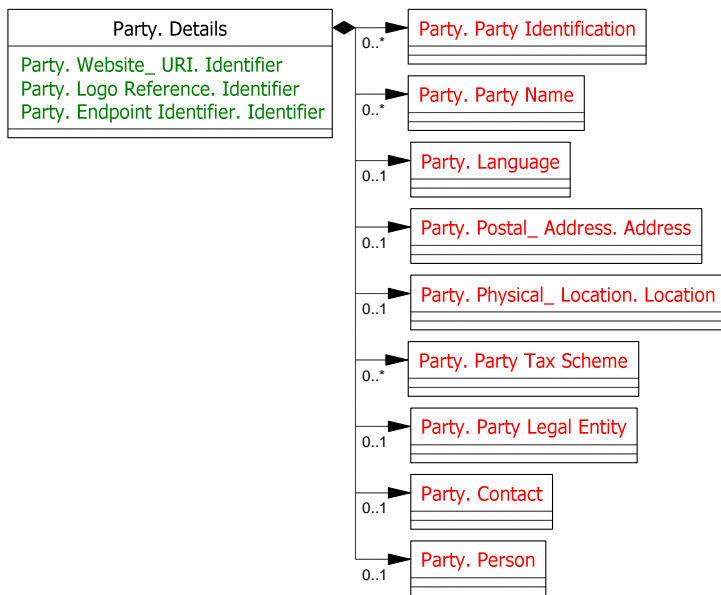

UBL Name **Party**

Definition Information about an organization, sub-organization, or individual fulfilling a role in a business process.

Crd	Short name	Requirement/Definition	Mapping/Comment
0.. 1	WebsiteURI	The Uniform Resource Identifier (URI) of the party.	08B CC: Party. URI. Communication 08B BIE: Trade_Party. URI. Universal_Communication
0.. 1	LogoReferenceID	A party's logo.	08B CC: Party. Referenced. Document 08B BIE: Trade_Party. Logo_Referenced.Referenced_Document
0.. 1	EndpointID	Identifies the end point of the routing service, e.g., the GS1 (Formerly EAN) Global Location Number, GLN.	08B CC: Party. URI. Communication 08B BIE: Trade_Party. End Point_URI.Universal_Communication
0.. unbound Association	PartyIdentification	An association to Party Identification.	08B CC: Party. Identification. Identifier 08B BIE: Trade_Party. Identification. Identifier
0.. unbound Association	PartyName	An association to Party Name. Party Name and/or Party Identification must be specified.	08B CC: Party. Name. Text 08B BIE: Trade_Party. Name. Text
0.. 1 Association	Language	An association to Language.	08B CC: Party. Language. Code 08B BIE:
0.. 1 Association	PostalAddress	The party's postal address. Use domestically defined guideline if applicable. Postal Address should be specified at document level.	08B CC: Party. Postal. Address 08B BIE: Trade_Party. Postal. Trade_Address
0.. 1 Association	PhysicalLocation	The party's physical location. Use only if Physical Location differs from Postal Address.	08B CC: Party. Specified. Location 08B BIE: Trade_Location. Details
0.. unbound Association	PartyTaxScheme	An association to Party Tax Scheme.	08B CC: Party. Specified. Registration 08B BIE: Trade_Party. Specified. Tax_Registration
0.. 1 Association	PartyLegalEntity	An association to Party Legal Entity.	08B CC: Party. Specified. Organization/Organization. Authorized. Registration 08B BIE: Trade_Party. Specified. Legal_Organization/Legal_Organization. Authorized. Legal_Registration
0.. 1 Association	Contact	An association to Contact.	08B CC: Party. Defined. Contact 08B BIE: Trade_Party. Defined. Trade_Contact
0.. 1 Association	Person	An association to a person. Provides means to specify how delivery of the ordered items should be done.	08B CC: Party. Specified. Person 08B BIE: Trade_Party. Specified. Representative_Person

PaymentMeans

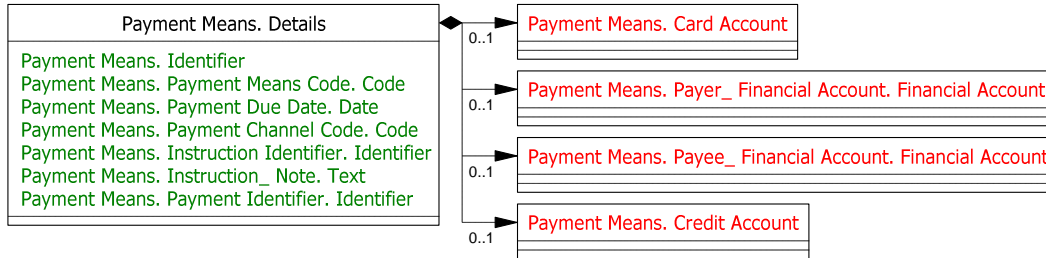

UBL Name **PaymentMeans**
 Definition Information about Payment Means.

Crđ	Short name	Requirement/Definition	Mapping/Comment
0.. 1	ID	Identifies the Payment Means.	08B CC: Payment Means. Identification. Identifier *Required to be added to CCL 08B BIE:
1.. 1	PaymentMeansCode	The Payment Means expressed as a code Code identifying the means of payment	08B CC: Payment Means. Type. Code 08B BIE: Trade Settlement_ Payment Means. Type. Code
0.. 1	PaymentDueDate	The date on which payment is due for the Payment Means.	08B CC: Payment Means. Related. Payment/ Payment. Due. Date Time 08B BIE: Trade_ Payment Terms. Due Date. Date Time
0.. 1	PaymentChannelCode	The Payment Channel, expressed as a code. Identifies the channel used for payment and used to identify appropriate validation of numbers and elements.	08B CC: Payment Means. Payment Channel. Code 08B BIE: Trade Settlement_ Payment Means. Payment Channel. Code
0.. 1	InstructionID	Identifies the Payment Instruction. An identifier allocated by the supplier to be stated in the payment so that the supplier can identify the payment when	08B CC: Payment Means. Related. Payment/ Payment. Instruction. Identifier 08B BIE:
0.. 1	InstructionNote	Free-form text applying to the Payment. Payment means instructions in free text	08B CC: Payment Means. Specified. Payment Instruction 08B BIE:
0.. 1	PaymentID	Identifies the Payment(s). Unique id for the payment issued by the seller as reference.	08B CC: Payment Means. Related. Payment/ Payment. Instruction. Identifier 08B BIE:
0.. 1 Association	CardAccount	An association to Card Account. To provide information about the creditcard used for payment that has been made. I.e. BII recommends that partners should not send payment instructions for creditcards inside the transactions. BII also recommends that only limited amount of creditcard detail is provided such as only last 4 or 6 digits of the creditcard number, sufficient for the receiver to recognize which of his cards was used for payment.	08B CC: Payment Means. Applicable. Financial Card 08B BIE: Trade Settlement_ Payment Means. Applicable. Trade Settlement_ Financial Card
0.. 1 Association	PayerFinancialAccount	An association to the payer's Financial Account. Use only in special circumstances where the Invoice is passed to the Payer's bank by or on behalf of the Payer. This gives the bank the information to complete the Payment by stating the source of the funds.	08B CC: Payment Means. Party. Financial Account 08B BIE: Trade Settlement_ Payment Means. Payer_ Party. Debtor_ Financial Account
0.. 1 Association	PayeeFinancialAccount	An association to the payee's Financial Account.	08B CC: Payment Means. Party. Financial Account 08B BIE: Trade Settlement_ Payment Means. Payee_ Party. Creditor_ Financial Account
0.. 1 Association	CreditAccount	An association to Credit Account.	08B CC: Payment Means. Credit. Financial Account 08B BIE: Trade Settlement_ Payment Means. Applicable. Trade Settlement_ Financial Card

PaymentTerms

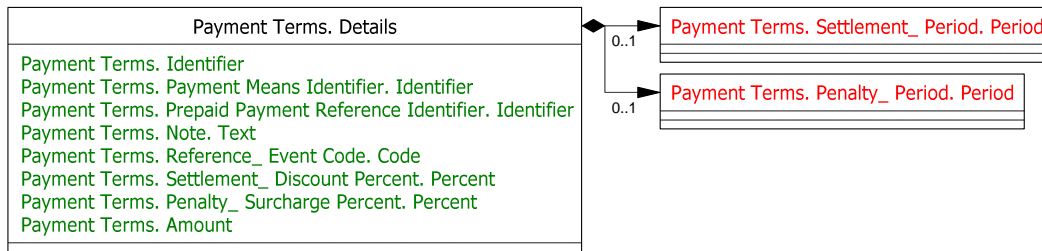

UBL Name **PaymentTerms**
 Definition Information about Payment Terms.

Crd	Short name	Requirement/Definition	Mapping/Comment
0.. 1	ID	Identifies the Payment Terms.	08B CC: Payment Terms. Identification. Identifier 08B BIE: Trade_ Payment Terms. Identification. Identifier
0.. 1	PaymentMeansID	Identifies the applicable Payment Means.	08B CC: Payment Terms. Payment Means. Identifier *Required to be added to CCL 08B BIE:
0.. 1	PrepaidPaymentReferenceID	Identifies a reference to a prepaid payment.	08B CC: Payment Terms. Prepaid Payment Reference. Identifier *Required to be added to CCL 08B BIE:
0.. 1	Note	Free-form text applying to the Payment Terms. This element may contain notes or any other similar information that is not contained explicitly in another structure.	08B CC: Payment Terms. Description. Text 08B BIE: Trade_ Payment Terms. Description. Text
0.. 1	ReferenceEventCode	The event from which terms are offered for a length of time, identified by a standard code. Used for coded payment collection instructions	08B CC: Payment Terms. Type. Code 08B BIE: Trade_ Payment Terms. From Event. Code
0.. 1	SettlementDiscountPercent	The settlement discount rate (percentage) offered for payment within the settlement period.	08B CC: Payment Terms. Settlement Discount. Rate 08B BIE:
0.. 1	PenaltySurchargePercent	The penalty rate (percentage) charged for late payment.	08B CC: Payment Terms. Settlement Surcharge. Rate 08B BIE:
0.. 1	Amount	The payment amount for the Payment Terms. If the PaymentTerm states a penalty charge, as indicated in the Note, the amount represents that charge amount. If the PaymentTerm states staged payments, as indicated in the Note, the amount will state the total amount payable.	08B CC: Payment Terms. Instructed. Amount 08B BIE: Trade_ Payment Terms. Instructed. Amount
0.. 1 Association	SettlementPeriod	An association to Settlement Period.	08B CC: Payment Terms. Settlement. Period 08B BIE: Specified_ Period. Details
0.. 1 Association	PenaltyPeriod	An association to Penalty Period. Use to specify the period to which a penalty [surcharge] applies.	08B CC: Payment Terms. Penalty. Period 08B BIE: Trade_ Payment Penalty Terms. Basis Period. Measure

Payment

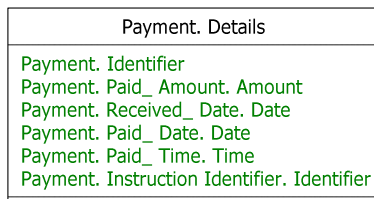

UBL Name **Payment**
 Definition Information directly relating to a specific payment.

Crd	Short name	Requirement/Definition	Mapping/Comment
0.. 1	ID	Identifies the payment.	08B CC: Payment. Identification. Identifier *Required to be added to CCL 08B BIE:
0.. 1	PaidAmount	The amount paid.	08B CC: Payment. Paid. Amount

Crd	Short name	Requirement/Definition	Mapping/Comment
			08B BIE:
0.. 1	ReceivedDate	The date on which the payment was received.	08B CC: Payment. Received. Date Time 08B BIE:
0.. 1	PaidDate	The date at which the payment was made.	08B CC: Payment. Requested Execution. Date Time 08B BIE:
0.. 1	PaidTime	The time at which the payment was made.	08B CC: Payment. Requested Execution. Date Time 08B BIE:
0.. 1	InstructionID	Identifies the Payment Instruction.	08B CC: Payment. Instruction. Identifier 08B BIE:

Period

Period. Details
Period. Start Date. Date Period. Start Time. Time Period. End Date. Date Period. End Time. Time Period. Duration. Measure Period. Description. Text

UBL Name **Period**
 Definition Information about a period of time.

Crd	Short name	Requirement/Definition	Mapping/Comment
0.. 1	StartDate	The start date of the period.	08B CC: Period. Start. Date Time 08B BIE: Specified_Period. Start. Date Time
0.. 1	StartTime	The start time of the period.	08B CC: Period. Start. Date Time 08B BIE: Specified_Period. Start. Date Time
0.. 1	EndDate	The end date of the period.	08B CC: Period. End. Date Time 08B BIE: Specified_Period. End. Date Time
0.. 1	EndTime	The end time of the period.	08B CC: Period. End. Date Time 08B BIE: Specified_Period. End. Date Time
0.. 1	DurationMeasure	The duration of a period, expressed as a code; ISO 8601.	08B CC: Period. Duration. Measure 08B BIE: Specified_Period. Duration. Measure
0.. unbound ed	Description	A description of the period.	08B CC: Period. Description. Text 08B BIE: Specified_Period. Description. Text

Person

Person. Details
Person. First_Name. Name Person. Family_Name. Name Person. Title. Text Person. Middle_Name. Name Person. Name_Suffix. Text Person. Job Title. Text Person. Organization_Department. Text

UBL Name **Person**
 Definition Information about a person.

Crd	Short name	Requirement/Definition	Mapping/Comment
0.. 1	FirstName	A person's forename or first name.	08B CC: Person. Given Name. Text 08B BIE:
0.. 1	FamilyName	A person's surname or family name.	08B CC: Person. Family Name. Text 08B BIE:
0.. 1	Title	A person's title of address, e.g., Mr, Ms, Dr, Sir.	08B CC: Person. Title. Text 08B BIE:
0.. 1	MiddleName	A person's middle name(s) and/or initial(s).	08B CC: Person. Middle Name. Text

Crd	Short name	Requirement/Definition	Mapping/Comment
0..1	NameSuffix	A suffix to a person's name, e.g., PhD, OBE, Jnr.	08B BIE: 08B CC: Person. Name Suffix. Text 08B BIE:
0..1	JobTitle	A person's job title within an organization (for a particular role).	08B CC: Person. Role. Text 08B BIE:
0..1	OrganizationDepartment	The department or subdivision of an organization that the person belongs to (for a particular role).	08B CC: Person. Organization Department. Text *Required to be added to CCL 08B BIE:

PhysicalAttribute

Physical Attribute. Details
Physical Attribute. Attribute Identifier. Identifier Physical Attribute. Description. Text

UBL Name **PhysicalAttribute**
 Definition Information about physical attributes.

Crd	Short name	Requirement/Definition	Mapping/Comment
1..1	AttributeID	Identifies the physical attribute.	08B CC: Characteristic. Identification. Identifier 08B BIE: Product_Characteristic. Identification. Identifier
0..unbounded	Description	The description of the physical attribute, expressed as text.	08B CC: Characteristic. Description. Text 08B BIE: Product_Characteristic. Description. Text

PriceList

Price List. Details
Price List. Identifier

UBL Name **PriceList**
 Definition Information about a Price List.

Crd	Short name	Requirement/Definition	Mapping/Comment
1..1	ID	Identifies the Price List.	08B CC: Document. Identification. Identifier 08B BIE: Referenced_Document. Issuer Assigned_ Identification. Identifier

Price

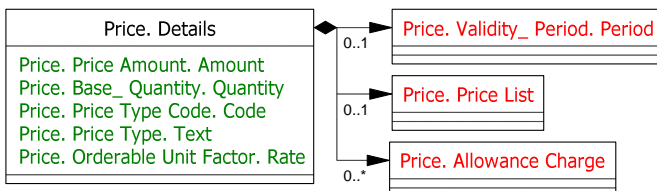

UBL Name **Price**
 Definition Information about the price.

Crd	Short name	Requirement/Definition	Mapping/Comment
1..1	PriceAmount	The price amount. The net price of the item including all allowances, charges and taxes but excluding VAT.	08B CC: Price. Charge. Amount 08B BIE: Trade_Price. Charge. Amount
0..1	BaseQuantity	The actual quantity to which the price applies. The base quantity to which the Price Amount	08B CC: Price. Basis. Quantity 08B BIE: Trade_Price. Basis. Quantity

Crđ	Short name	Requirement/Definition	Mapping/Comment
		applies. The Data Type attribute Unit.Code specifies the Unit of Measure.	
0.. 1	PriceTypeCode	The price type, expressed as a code.	08B CC: Price. Type. Code 08B BIE: Trade_ Price. Type. Code
0.. 1	PriceType	The price type, expressed as text.	08B CC: Price. Type. Text *Required to be added to CCL 08B BIE:
0.. 1	OrderableUnitFactorRate	The factor by which the base price unit can be converted to the orderable unit. The factor used to convert the Base Quantity to an Orderable Unit. Must be specified if the Orderable Unit differs from the Base Quantity. If not present, assumed value is 1.	08B CC: Price. Unit Conversion Factor. Numeric 08B BIE: Trade_ Price. Order_ Unit Conversion Factor. Numeric
0.. 1 Association	ValidityPeriod	An association to Validity Period. The period during which the price is valid.	08B CC: Price. Validity. Period 08B BIE: Trade_ Price. Validity. Specified_ Period
0.. 1 Association	PriceList	A reference to a Price List. Do not use for Catalogue-based purchasing; use Catalogue reference instead. A reference to the price list on which the price is based.	08B CC: Price. Referenced. Document 08B BIE: Trade_ Price. Referenced. Referenced_ Document
0.. unbound Association	AllowanceCharge	An association to Allowance Charge. Use to specify Allowances and Charges included in the Price. Information only; not used for calculation.	08B CC: Price. Applied. Allowance Charge 08B BIE: Trade_ Price. Applied. Trade_ Allowance Charge

PricingReference

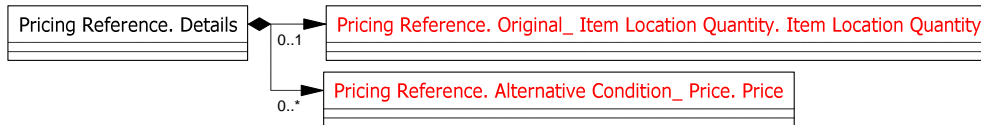

UBL Name	PricingReference		
Definition	A reference to Pricing Information.		
0.. 1 Association	OriginalItemLocationQuantity	An association to the original Item Location Quantity.	08B CC: Pricing Reference. Original. Item Location Quantity *Required to be added to CCL 08B BIE:
0.. unbound Association	AlternativeConditionPrice	The price expressed in terms other than the actual price, e.g., the list price v. the contracted price, or the price in bags v. the price in kilos, or the list price in bags v. the contracted price in kilos.	08B CC: Pricing Reference. Alternative Condition. Price *Required to be added to CCL 08B BIE: Trade_ Price. Details

QuotationLine

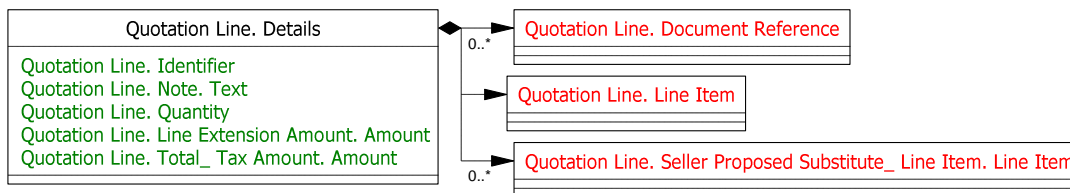

UBL Name	QuotationLine		
Definition	Information about a Quotation Line.		

Crđ	Short name	Requirement/Definition	Mapping/Comment
0.. 1	ID	Identifies the Quotation Line.	08B CC: Trade Line Item. Identification. Identifier 08B BIE:
0.. 1	Note	Free-form text applying to the Quotation Line. This element may contain notes or any other similar information that is not contained explicitly in another structure.	08B CC: Trade Line Item. Information. Text 08B BIE:

0.. 1	Quantity	The quantity of the item quoted.	08B CC: Trade Line Item. Chargeable Unit.
-------	----------	----------------------------------	---

Crd	Short name	Requirement/Definition	Mapping/Comment
			Quantity 08B BIE:
0.. 1	LineExtensionAmount	The total amount for the Quotation Line, including Allowance Charges but net of taxes.	08B CC: Trade Line Item. Charge. Amount 08B BIE:
0.. 1	TotalTaxAmount	The total tax amount for the Quotation Line.	08B CC: Trade Line Item. Invoice. Amount 08B BIE:
0.. unbound Association	DocumentReference	An association to Document Reference.	08B CC: Trade Line Item. Reference. Document 08B BIE: Referenced_ Document. Details
1.. 1 Association	LineItem	An association to Line Item.	08B CC: Trade Line Item. Specified. Product 08B BIE: Supply Chain_ Trade Line Item. Details / Supply Chain_ Trade Agreement. Details
0.. unbound Association	SellerProposedSubstituteLineItem	An association to a proposed substitute Line Item.	08B CC: Trade Line Item. Substitute. Trade Line Item *Required to be added to CCL 08B BIE: Supply Chain_ Trade Line Item. Details / Supply Chain_ Trade Agreement. Details

RelatedItem

Related Item. Details
Related Item. Identifier Related Item. Quantity Related Item. Description. Text

UBL Name **RelatedItem**
Definition Information about the relationship between two items.

Crd	Short name	Requirement/Definition	Mapping/Comment
1.. 1	ID	An identifier for the related item.	08B CC: Product. Identification. Identifier 08B BIE:
0.. 1	Quantity	The quantity that applies to the relationship.	08B CC: Product. Relevant. Quantity *Required to be added to CCL 08B BIE:
0.. unbound ed	Description	A description for the relationship.	08B CC: Product. Description. Text 08B BIE:

ReminderLine

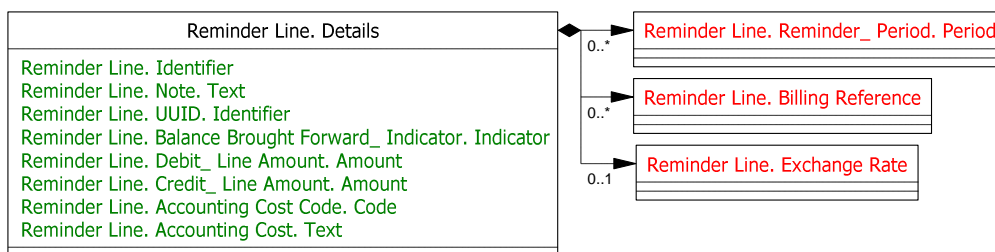

UBL Name **ReminderLine**
Definition Information about a Line on a Reminder document.

Crd	Short name	Requirement/Definition	Mapping/Comment
1.. 1	ID	Identifies the Reminder Line.	08B CC: Trade Line Item. Identification. Identifier 08B BIE:
0.. 1	Note	Free-form text applying to the Reminder Line. This element may contain notes or any other similar information that is not contained explicitly in another structure.	08B CC: Trade Line Item. Information. Text 08B BIE:
0.. 1	UUID	A universally unique identifier for an instance of this ABIE.	08B CC: Trade Line Item. UUID. Identifier *Required to be added to CCL 08B BIE:
0.. 1	BalanceBroughtForwardIndicator	If true, indicates that the Remonder Line contains a balance brought forward.	08B CC: Trade Line Item. Type Extension. Code 08B BIE:

Crd	Short name	Requirement/Definition	Mapping/Comment
0.. 1	DebitLineAmount	The amount debited on the Reminder Line.	08B CC: Trade Line Item. Specified. Trade Settlement/Trade Settlement. Debit. Amount *Required to be added to CCL 08B BIE:
0.. 1	CreditLineAmount	The amount credited on the Reminder Line.	08B CC: Trade Line Item. Specified. Trade Settlement/Trade Settlement. Credit. Amount *Required to be added to CCL 08B BIE:
0.. 1	AccountingCostCode	The buyer's accounting code applied to the Reminder Line.	08B CC: Trade Line Item. Specified. Trade Settlement/Trade Settlement. Specified. Accounting Account/Accounting Account. Identification. Identifier 08B BIE:
0.. 1	AccountingCost	The buyer's accounting cost centre applied to the Reminder Line, expressed as text.	08B CC: Trade Line Item. Specified. Trade Settlement/Trade Settlement. Specified. Accounting Account/Accounting Account. Cost Assignment Reference. Text 08B BIE:
0.. unbound Association	ReminderPeriod	An association to Period.	08B CC: Trade Line Item. Reminder. Period *Required to be added to CCL 08B BIE: Specified_Period. Details
0.. unbound Association	BillingReference	An association to Billing Reference	08B CC: Trade Line Item. Specified. Trade Settlement 08B BIE: Supply Chain_Trade Settlement. Details
0.. 1 Association	ExchangeRate	An association to Exchange Rate (between the Reminder Line Currency and the Related Document currency).	08B CC: Trade Line Item. Applicable. Currency Exchange 08B BIE: Trade_Currency Exchange. Details

RequestForQuotationLine

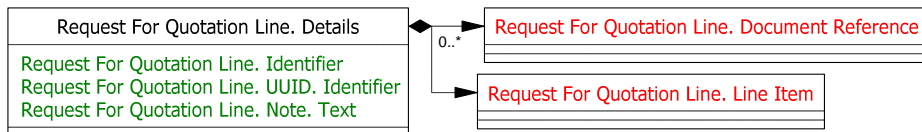

UBL Name

RequestForQuotationLine

Definition

Information about a Line on a Request For Quotation.

Crd	Short name	Requirement/Definition	Mapping/Comment
0.. 1	ID	Identifies the Request For Quotation Line.	08B CC: Trade Line Item. Identification. Identifier 08B BIE:
0.. 1	UUID	A universally unique identifier for an instance of this ABIE.	08B CC: Trade Line Item. UUID. Identifier *Required to be added to CCL 08B BIE:
0.. 1	Note	Free-form text applying to the Request For Quotation Line. This element may contain notes or any other similar information that is not contained explicitly in another structure.	08B CC: Trade Line Item. Information. Text 08B BIE:
0.. unbound Association	DocumentReference	An association to Document Reference.	08B CC: Trade Line Item. Reference. Document 08B BIE: Referenced_Document. Details
1.. 1 Association	LineItem	An association to Line Item.	08B CC: Trade Line Item. Specified. Product 08B BIE: Supply Chain_Trade Line Item. Details / Supply Chain_Trade Agreement. Details

Response

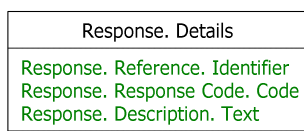

UBL Name

Response

Definition

Information about responses to a document (at the application level).

Crd	Short name	Requirement/Definition	Mapping/Comment
1..1	ReferenceID	Identifies the section (or line) of the document to which the response applies.	08B CC: Response. Identification. Identifier 08B BIE:
0..1	ResponseCode	A code for the description of the response to the transaction document.	08B CC: Response. Type. Code 08B BIE:
0.. unbound	Description	The description of the response to the transaction document.	08B CC: Response. Content. Text 08B BIE:

SecondaryHazard

Secondary Hazard. Details
<ul style="list-style-type: none"> Secondary Hazard. Identifier Secondary Hazard. Placard Notation. Text Secondary Hazard. Placard Endorsement. Text Secondary Hazard. Emergency Procedures Code. Code Secondary Hazard. Extension. Text

UBL Name

SecondaryHazard

Definition

Information about Secondary Hazard (related to a Hazardous Item).

Crd	Short name	Requirement/Definition	Mapping/Comment
0..1	ID	Identifies the Secondary Hazard.	08B CC: Dangerous Goods. Subsidiary Risk. Identifier 08B BIE:
0..1	PlacardNotation	The placard notation corresponding to the hazard class of the hazardous commodity. Can also be the hazard identification number of the orange placard (upper part) required on the means of transport.	08B CC: Dangerous Goods. Upper Part Orange Hazard Placard. Identifier 08B BIE:
0..1	PlacardEndorsement	The placard endorsement that is to be shown on the shipping papers for the hazardous commodity. Can also be used for the number of the orange placard (lower part) required on the means of transport.	08B CC: Dangerous Goods. Lower Part Orange Hazard Placard. Identifier 08B BIE:
0..1	EmergencyProceduresCode	Emergency procedures for hazardous goods, expressed as a code.	08B CC: Dangerous Goods. EMS. Identifier 08B BIE:
0..1	Extension	Additional information about the hazardous substance. Can be used to specify information such as the type of regulatory requirements that apply to a description.	08B CC: Dangerous Goods. Remark. Text 08B BIE:

Signature

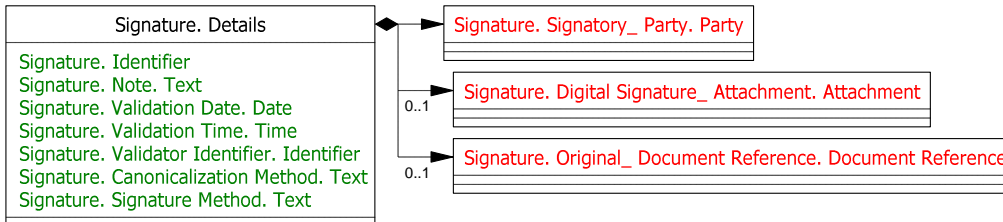

UBL Name

Signature

Definition

Information about signature. A placeholder for signature.

Crd	Short name	Requirement/Definition	Mapping/Comment
1..1	ID	An identifier for the Signature.	08B CC: Signature. Identification. Identifier *Required to be added to CCL 08B BIE:
0..1	Note	Free form text about the signature or the circumstances where the signature has been used.	08B CC: Signature. Note. Text *Required to be added to CCL 08B BIE:

Crd	Short name	Requirement/Definition	Mapping/Comment
0.. 1	ValidationDate	Specifies the date when the signature was approved.	08B CC: Signature. Validation. Date *Required to be added to CCL 08B BIE:
0.. 1	ValidationTime	Specifies the time when the signature was approved.	08B CC: Signature. Validation. Time *Required to be added to CCL 08B BIE:
0.. 1	ValidatorID	Identifies the organization, person, service or server that has validated the signature.	08B CC: Signature. Validator. Identifier *Required to be added to CCL 08B BIE:
0.. 1	CanonicalizationMethod	The mathematical logic method used by the Signature.	08B CC: Signature. Canonicalization Method. Identifier *Required to be added to CCL 08B BIE:
0.. 1	SignatureMethod	The method of signature.	08B CC: Signature. Singature Method. Text *Required to be added to CCL 08B BIE:
1.. 1 Association	SignatoryParty	An association to the signing Party.	08B CC: Signature. Signatory. Party *Required to be added to CCL 08B BIE: Trade_Party. Details
0.. 1 Association	DigitalSignatureAttachment	Refers to the actual encoded signature (e.g., in XMLDSIG format).	08B CC: Signature. Digital Signature. Attachment *Required to be added to CCL 08B BIE: Referenced_Document. Details
0.. 1 Association	OriginalDocumentReference	A reference to the actual document that the signature applies to. For evidentiary purposes, this may be the document image that the signatory party saw when applying their signature.	08B CC: Signature. Original. Document Reference *Required to be added to CCL 08B BIE: Referenced_Document. Details

StatementLine

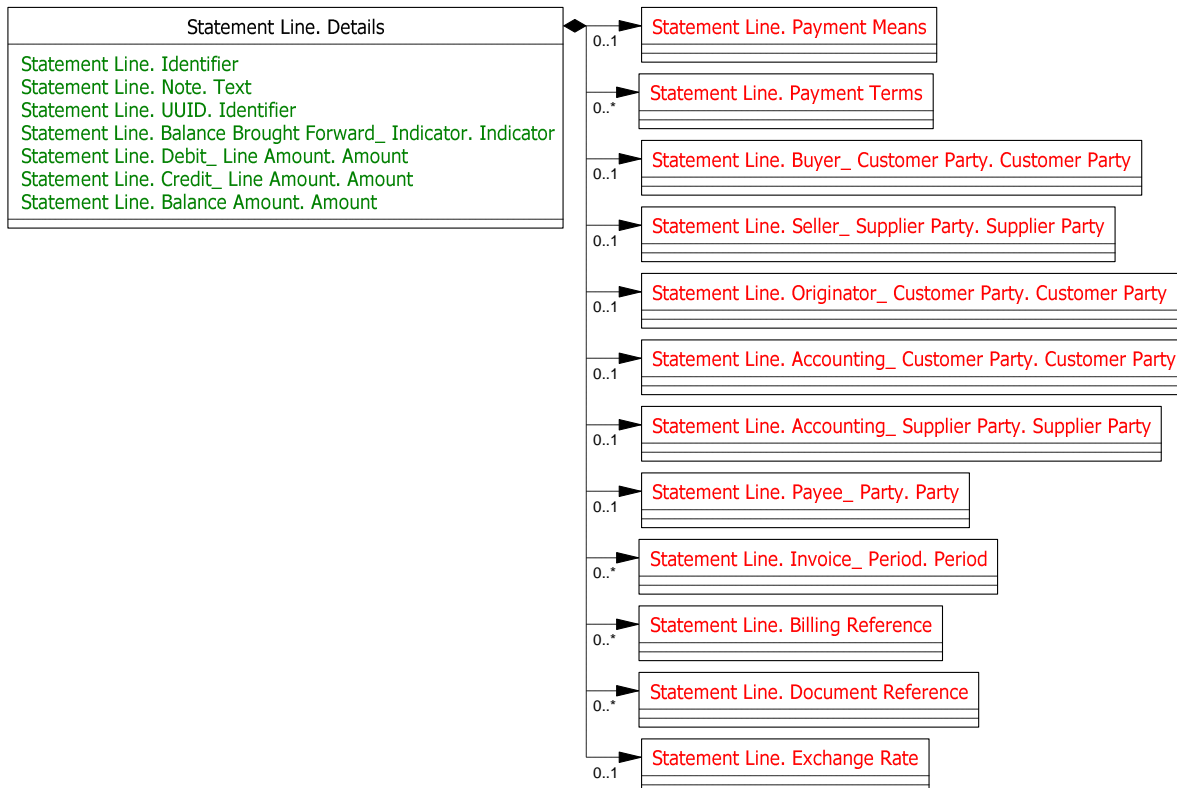

UBL Name

StatementLine

Definition

Information about a Line on a Statement of Account.

Crd	Short name	Requirement/Definition	Mapping/Comment
1.. 1	ID	Identifies the Statement Line.	08B CC: Trade Line Item. Identification. Identifier 08B BIE:

0.. 1	Note	Free-form text applying to the Statement Line. This element may contain notes or any other similar information that is not contained explicitly in another structure.	08B CC: Trade Line Item. Information. Text 08B BIE:
0.. 1	UUID	A universally unique identifier for an instance of this ABIE.	08B CC: Trade Line Item. UUID. Identifier *Required to be added to CCL 08B BIE:
0.. 1	BalanceBroughtForwardIndi	If true, indicates that the Statement Line contains	08B CC: Trade Line Item. Type Extension. Code

Crđ	Short name	Requirement/Definition	Mapping/Comment
	icator	a balance brought forward.	08B BIE:
0.. 1	DebitLineAmount	The amount debited on the Statement Line.	08B CC: Trade Line Item. Specified. Trade Settlement/Trade Settlement. Debit. Amount *Required to be added to CCL 08B BIE:
0.. 1	CreditLineAmount	The amount credited on the Statement Line.	08B CC: Trade Line Item. Specified. Trade Settlement/Trade Settlement. Credit. Amount *Required to be added to CCL 08B BIE:
0.. 1	BalanceAmount	The balance amount on the Statement Line.	08B CC: Trade Line Item. Balance. Amount *Required to be added to CCL 08B BIE:
0.. 1 Association	PaymentMeans	An association to Payment Means.	08B CC: Trade Line Item. Specified. Trade Settlement/Trade Settlement. Specified. Payment Means 08B BIE: Trade Settlement_ Payment Means. Details
0.. unbound Association	PaymentTerms	An association to Payment Terms.	08B CC: Trade Line Item. Specified. Trade Settlement/Trade Settlement. Specified. Payment Terms 08B BIE: Trade_ Payment Terms. Details
0.. 1 Association	BuyerCustomerParty	An association to Buyer.	08B CC: Trade Line Item. Specified. Trade Settlement/Trade Settlement. Payer. Party 08B BIE: Trade_ Party. Details
0.. 1 Association	SellerSupplierParty	An association to Seller.	08B CC: Trade Line Item. Specified. Trade Settlement/Trade Settlement. Payee. Party 08B BIE: Trade_ Party. Details
0.. 1 Association	OriginatorCustomerParty	An association to Originator.	08B CC: Trade Line Item. Originator Customer. Party *Required to be added to CCL 08B BIE: Trade_ Party. Details
0.. 1 Association	AccountingCustomerParty	An association to Accounting Customer Party.	08B CC: Trade Line Item. Specified. Trade Settlement/Trade Settlement. Invoicee. Party 08B BIE: Trade_ Party. Details
0.. 1 Association	AccountingSupplierParty	An association to Accounting Supplier Party.	08B CC: Trade Line Item. Specified. Trade Settlement/Trade Settlement. Invoicer. Party 08B BIE: Trade_ Party. Details
0.. 1 Association	PayeeParty	An association to Payee.	08B CC: Trade Line Item. Specified. Trade Settlement/Trade Settlement. Payee. Party 08B BIE: Trade_ Party. Details
0.. unbound Association	InvoicePeriod	An association to Invoice Period.	08B CC: Trade Line Item. Invoice. Period *Required to be added to CCL 08B BIE: Specified_ Period. Details
0.. unbound Association	BillingReference	An association to Billing Reference.	08B CC: Trade Line Item. Specified. Trade Settlement/Trade Settlement. Referenced. Document 08B BIE: Supply Chain_ Trade Settlement. Details
0.. unbound Association	DocumentReference	An association to Document Reference.	08B CC: Trade Line Item. Reference. Document 08B BIE: Referenced_ Document. Details
0.. 1 Association	ExchangeRate	An association to Exchange Rate (between the Statement Line currency and the Related Document Currency).	08B CC: Trade Line Item. Applicable. Currency Exchange 08B BIE: Trade_ Currency Exchange. Details

SupplierParty

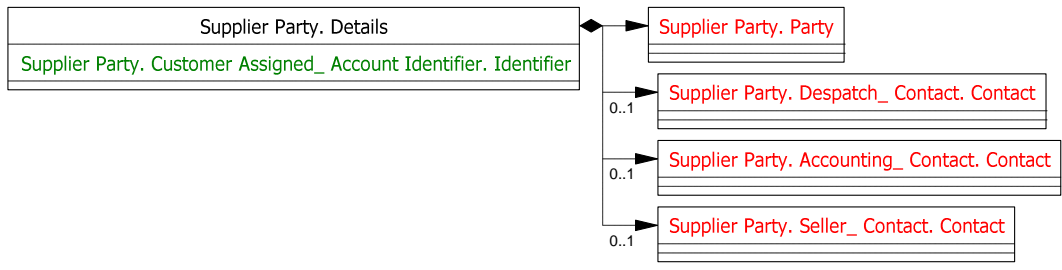

UBL Name **SupplierParty**
 Definition Information about the Supplier Party.

Crd	Short name	Requirement/Definition	Mapping/Comment
0.. 1	CustomerAssignedAccountID	The customer's internal identifier for the supplier. Use only the ID, not the other Data Type attributes.	08B CC: Party. Identification. Identifier 08B BIE:
1.. 1 Association	Party	An association to Party.	08B CC: Party. Details 08B BIE: Trade_ Party. Details
0.. 1 Association	DespatchContact	An association to Despatch Contact.	08B CC: Party. Defined. Contact 08B BIE: Trade_ Party. Defined. Trade_ Contact
0.. 1 Association	AccountingContact	An association to Supplier Accounting Contact.	08B CC: Party. Defined. Contact 08B BIE: Trade_ Party. Defined. Trade_ Contact
0.. 1 Association	SellerContact	An association to Seller Contact.	08B CC: Party. Defined. Contact 08B BIE: Trade_ Party. Defined. Trade_ Contact

TaxCategory

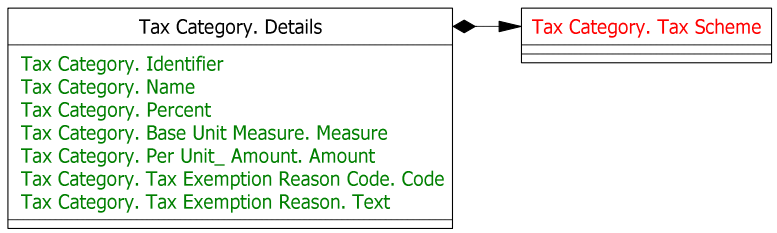

UBL Name **TaxCategory**
 Definition Information about a tax category.

Crd	Short name	Requirement/Definition	Mapping/Comment
1.. 1	ID	Identifies the tax category.	08B CC: Tax. Category. Code 08B BIE: Trade_ Tax. Category. Code
0.. 1	Name	The name of the tax category. Do not use.	08B CC: Tax. Category Name. Text 08B BIE: Trade_ Tax. Category Name. Text
0.. 1	Percent	The tax rate for the category, expressed as a percentage. Use if tax is percentage based (rather than unit based).	08B CC: Tax. Calculated. Rate 08B BIE: Trade_ Tax. Calculated. Rate
0.. 1	BaseUnitMeasure	Where a tax is applied at a certain rate per unit, the measure of units on which the tax calculation is based.	08B CC: Tax. Basis. Quantity 08B BIE: Trade_ Tax. Basis. Quantity
0.. 1	PerUnitAmount	Where a tax is applied at a certain rate per unit, the rate per unit applied.	08B CC: Tax. Basis. Amount 08B BIE: Trade_ Tax. Unit_ Basis. Amount
0.. 1	TaxExemptionReasonCode	The reason for tax being exempted expressed as a code. Coded reasons for why item is tax exempt.	08B CC: Tax. Exemption Reason. Code 08B BIE: Trade_ Tax. Exemption Reason. Code
0.. 1	TaxExemptionReason	The reason for tax being exempted. Textual reason why item is tax exempt.	08B CC: Tax. Exemption Reason. Text 08B BIE: Trade_ Tax. Exemption Reason. Text
1.. 1 Association	TaxScheme	An association to Tax Scheme.	08B CC: Tax. Regime Type. Code 08B BIE: Trade_ Tax. Regime Type. Code

TaxScheme

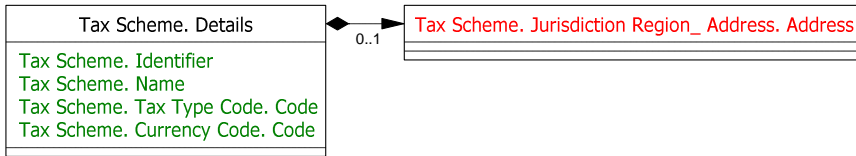

UBL Name **TaxScheme**
 Definition Information about a tax scheme.

Crd	Short name	Requirement/Definition	Mapping/Comment
1..1	ID	Identifies the tax scheme.	08B CC: Tax. Regime Type. Code 08B BIE: Trade_Tax. Regime Type. Code
0..1	Name	The name of the tax scheme.	08B CC: Tax. Regime Type. Text 08B BIE: Trade_Tax. Regime Type. Text
0..1	TaxTypeCode	An identifier for the tax type.	08B CC: Tax. Type. Code 08B BIE: Trade_Tax. Type. Code
0..1	CurrencyCode	The currency in which the tax is collected and reported, expressed as a code.	08B CC: Tax. Currency. Code 08B BIE: Trade_Tax. Currency. Code
0..1 Association	JurisdictionRegionAddress	An association with Address (of taxation jurisdiction).	08B CC: Tax. Jurisdiction. Text 08B BIE: Trade_Tax. Jurisdiction. Text

TaxSubtotal

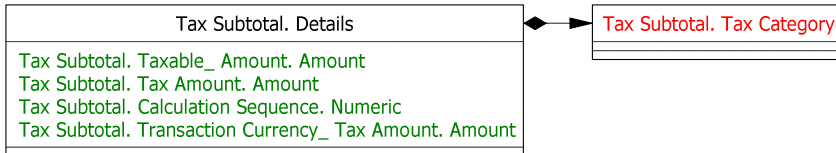

UBL Name **TaxSubtotal**
 Definition Information about the subtotal for a particular tax category within a tax scheme, such as standard rate within VAT.

Crd	Short name	Requirement/Definition	Mapping/Comment
1..1	TaxableAmount	The net amount to which the tax percent (rate) is applied to calculate the tax amount.	08B CC: Tax. Basis. Amount 08B BIE: Trade_Tax. Basis. Amount
1..1	TaxAmount	The amount of tax stated explicitly.	08B CC: Tax. Calculated. Amount 08B BIE: Trade_Tax. Calculated. Amount
0..1	CalculationSequenceNumeric	Identifies the numerical order sequence in which taxes are applied when multiple taxes are attracted. If all taxes apply to the same taxable amount, CalculationSequenceNumeric will be '1' for all taxes. Used to specify the sequence in which Tax Subtotals are calculated. Use if more than one Tax Subtotal is present	08B CC: Tax. Calculation Sequence. Numeric 08B BIE: Trade_Tax. Calculation Sequence. Numeric
0..1	TransactionCurrencyTaxAmount	The tax amount, expressed in the currency used for invoicing. The tax amount, expressed in the currency used for tax reporting. Must be used if the currency used for tax values differs from the default currency for the document.	08B CC: Tax. Transaction Currency. Amount *Required to be added to CCL 08B BIE:
1..1 Association	TaxCategory	An association to Tax Category.	08B CC: Tax. Category Name. Text 08B BIE: Trade_Tax. Category. Code

TaxTotal

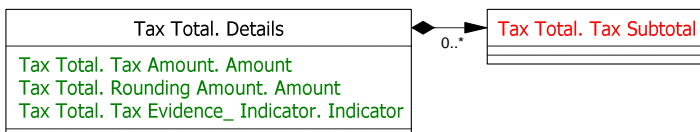

UBL Name

TaxTotal

Definition

Information about a total amount of a particular type of tax.

Crd	Short name	Requirement/Definition	Mapping/Comment
1..1	TaxAmount	The total tax amount for particular tax scheme e. g. VAT; the sum of each of the tax subtotals for each tax category within the tax scheme.	08B CC: Tax. Calculated. Amount 08B BIE: Trade_Tax. Calculated. Amount
0..1	RoundingAmount	The rounding amount (positive or negative) added to the calculated tax total to produce the rounded TotalTaxAmount.	08B CC: Tax. Rounding. Amount *Required to be added to CCL 08B BIE:
0..1	TaxEvidenceIndicator	An indicator as to whether these totals are recognized as legal evidence for taxation purposes. Only used in special circumstances. For standard VAT, value is always True. Only False for proforma documents.	08B CC: Tax. Evidence. Indicator *Required to be added to CCL 08B BIE:
0.. unbound Association	TaxSubtotal	An association to Tax Subtotal.	08B CC: Tax. Details 08B BIE: Trade_Tax. Details

Temperature

Temperature. Details
Temperature. Attribute Identifier. Identifier
Temperature. Measure
Temperature. Description. Text

UBL Name

Temperature

Definition

Information about temperature.

Crd	Short name	Requirement/Definition	Mapping/Comment
1..1	AttributeID	An identifier for temperature.	08B CC: Temperature. Type. Code 08B BIE:
1..1	Measure	The temperature measurement value.	08B CC: Temperature. Value. Measure 08B BIE:
0.. unbound ed	Description	A description of the temperature measurement.	08B CC: Temperature. Description. Text 08B BIE:

TradingTerms

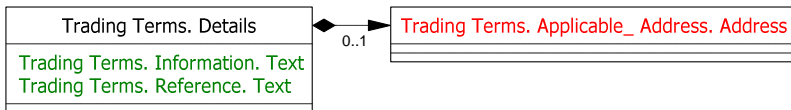

UBL Name

TradingTerms

Definition

Information about the terms of a trade agreement.

Crd	Short name	Requirement/Definition	Mapping/Comment
0.. unbound ed	Information	The terms in text.	08B CC: Trade Agreement. Information. Text *Required to be added to CCL 08B BIE:
0..1	Reference	A reference to the terms.	08B CC: Trade Agreement. Reference. Text 08B BIE:
0..1 Association	ApplicableAddress	An association to the address at which the trading terms apply.	08B CC: Trade Agreement. Applicable. Address *Required to be added to CCL 08B BIE: Trade_ Address. Details

TransactionConditions

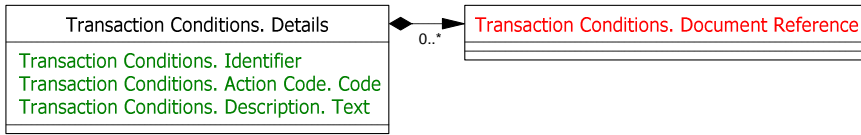

.....
UBL Name **TransactionConditions**
Definition Information about purchasing, sales, or payment conditions.

Crd	Short name	Requirement/Definition	Mapping/Comment
0.. 1	ID	Identifies conditions of the transaction, typically Purchase/Sales Conditions.	08B CC: Payment Terms. Identification. Identifier 08B BIE: Trade_ Payment Terms. Identification. Identifier
0.. 1	ActionCode	An action relating to sales or payment conditions, expressed as a code. Use bilaterally agreed code.	08B CC: Payment Terms. Type. Code 08B BIE: Trade_ Payment Terms. Type. Code
0.. unbound ed	Description	The description of the transaction conditions. Use in the absence of an Action Code.	08B CC: Payment Terms. Description. Text 08B BIE: Trade_ Payment Terms. Description. Text
0.. unbound ed Association	DocumentReference	An association to Document Reference.	08B CC: Payment Terms. Referenced. Document *Required to be added to CCL 08B BIE: Referenced_ Document. Details